



PRODUCT CATALOG

833.772.3667 | [SERVICESPRING.COM](https://www.servicesspring.com)

NEW CUSTOMERS
Save 5% on your
first order!*

If you're a new business or have never ordered from SSC, we have a special offer just for you. When placing your first order, ask for your new customer discount. You'll receive 5% off the merchandise total on your first order!

**This offer may not be combined with any other discounts or offers. Maximum discount per order shall not exceed \$50.00.*

ORDER DESK,
SALES & TECHNICAL
SUPPORT

Service Spring's exclusive "One-call Solution" is the fastest source for quotes, orders, tracking information, technical support and much more. We provide the solutions to your problems without the hassle or runaround. Call us toll free at 833.772.3667. We strive to exceed your expectations with every opportunity!

SSC HAS UPS
GUARANTEED
SAME-DAY SHIPPING

UPS Ground orders placed by 1:00pm EST & UPS Air orders placed by 4:30pm EST (1:30pm PT), will ship the same day, guaranteed! Orders today ship today – guaranteed.

PAYMENT PORTAL

Check account status and pay your invoices online anytime at payment.sscorp.com

ORDER 24/7
ONLINE AT
servicespring.com

You're just a mouse click away from ordering online. It's easy to use and requires no special training or software. Log on to order anytime, receive product pricing, watch videos, order confirmations and UPS tracking details.

Not a registered user? Register online at servicespring.com

TABLE OF CONTENTS

Account Application	163	Dock Equipment.....	142-144	Miscellaneous Hardware..	42-43	Springs
Aluminum Retainer	123	Door Bumpers	39	Mystic Motorized Screens	138	Custom Extension Springs
BD Loops	90	Entry Door Closers	113	Operator Brackets	38	Price & Size Chart.....
Bearings	30	Exhaust Ports.....	38	Ordering Information....	4-5, 8-10	Extension Springs
Bottom Brackets.....	28	Extension Hardware.....	34	Perforated Angle	44	Long Length
Brush Seal	124	Fasteners.....	40-41	Plates.....	30-31	Powder Coating
Cable	24	Folding Gate.....	145	Pneumatic Coil Cord & Reel ...	97	Torsion Springs
Cable Drums.....	22	Forms	151	Quiet Hinge	25	Spring Filler
Cable Fittings	25	Gate		Residential		Struts
Carriage Door.....	35-36	Hinge Hardware.....	108	Allstar	75	Sure-Stop Brackets.....
Chain Hoists & Accessories....	32	Liftmaster	102-103	Digi-Code	73	Tools
Chain Parts & Tools.....	33	Linear	107	Genie.....	70-72	Top Fixtures
Chase Vinyl Strip Doors.....	140	Hardware Boxes.....	42	Guardian.....	66-67	Track.....
Commercial		Hardware Pulleys & Forks.....	23	Heddolf	76	Truck Trailer Doors
Edge Systems.....	92	Hinges	26	Universal	76	Weather Seal
LiftMaster	78-87	Index.....	166-168	Liftmaster	48-62	
Marantec	89	Lifestyle Screens	139	Linear	63-64	
Loop Tools & Accessories	89	Locks	37	Marantec	69	
Motion Detector	98	Loop Tools & Accessories..	89-91	Multi-code	74	
Photo cells.....	83	Low Headroom.....	39	Universal	76	
Wall station.....	99	Lubricants	126-127	Rollers.....	27	
Cones	20	Miller Edge	94-96	Shafts.....	46	
Couplers.....	45	Mini Warehouse.....	136-137	Shipping Zones	2-3	

TERMS & CONDITIONS

INSUFFICIENT FUNDS

Checks and ACH's that are returned due to non-sufficient funds will incur a \$35 charge.

MINIMUM ORDER CHARGE

No order processing charges on product orders over \$25.00

Orders of merchandise that total less than \$25 (excluding freight, tax and labor) will be subject to a **minimum order charge of \$25.00**. In the event that an order is being shipped to multiple addresses, each "ship-to" address with a merchandise total under \$25 will be subject to the **minimum order charge**. The charge is designed to offset the costs associated with receiving, filling, packaging & processing the payment for small orders.

FREIGHT

FOB Origin, Freight Prepaid & Add

Please inspect all arriving orders for damage or shortage BEFORE signing for the goods. **Products must be inspected at time of delivery** and damages or shortages MUST be noted on delivery receipt.

WARRANTY

All products are covered by a 90 Day Warranty

If any product should fail during this period due to faulty material or workmanship, Service Spring will replace that item. Service Spring assumes no responsibility for damage due to accident, neglect or improper installation. In no event shall Service Spring be liable for any incidental or labor costs. Service Spring will extend to customers warranties from vendors.

RETURNS & CANCELLATIONS

Please be certain all information is correct when placing an order

Due to the speed at which we process orders it may not be possible to cancel or modify an order after it has been entered. Made-to-order and special-order products, including garage doors, are nonreturnable. Standard stock items may be returned by contacting Service Spring and obtaining a Return Goods Authorization Number. Returning merchandise must be returned within 15 working days of the original invoice and must be accompanied by an RGA Number. Return goods may be subject to a restocking fee.

PRICES LISTED IN OUR CATALOG ARE NET

Prices are subject to change without notice. All pricing in U.S. dollars. View most current pricing by logging into our [website servicespring.com](http://www.servicespring.com).



SSC's INTERACTIVE CATALOG

Use your **phone's camera** or download a free app to scan the QR codes throughout the catalog. We recommend **QR Code Reader for iPhone** by MixerBox Inc or **Lightning QRcode Scanner** for Android users. This allows you to check pricing, download documents and watch videos!



TABLE OF CONTENTS

All Pricing Subject To Change

SSC'S NEW LOCATIONS MEAN WE WILL SHIP TO YOU FASTER

ALL ACROSS THE COUNTRY, SSC IS ADDING NEW LOCATIONS TO GET YOUR PRODUCTS TO YOU FASTER WITH UPS GROUND!

TOLEDO, OHIO

SSC Corporate Office

1703 Tollgate Dr., Maumee, OH 43537

Manufacturing & Distributing

6615 Maumee Western Rd., Maumee, OH 43537

VISALIA, CALIFORNIA

Manufacturing & Distributing

7918 W Doe Ave., Suite A, Visalia, CA 93291

BALTIMORE, MARYLAND

Service Center

9060 Junction Dr., Ste. 2, Annapolis Junction, MD 20701

CHICAGO, ILLINOIS

Service Center

260 Madsen Dr., Suite 100, Bloomingdale, IL 60108

DALLAS, TEXAS

Service Center

4450 W. Walnut Hill Ln., Suite 120, Irving, TX 75038

DETROIT, MICHIGAN

Service Center

1322 Rankin Dr., Troy, MI 48083

INDIANAPOLIS, INDIANA

Service Center

9634 East 150th Street Noblesville, IN 46060

ORLANDO, FLORIDA

Service Center

7600 Kingspointe Parkway, Orlando, FL 32819

PHOENIX, ARIZONA

Service Center

4380 W. Lower Buckeye Rd., Phoenix, AZ 85043

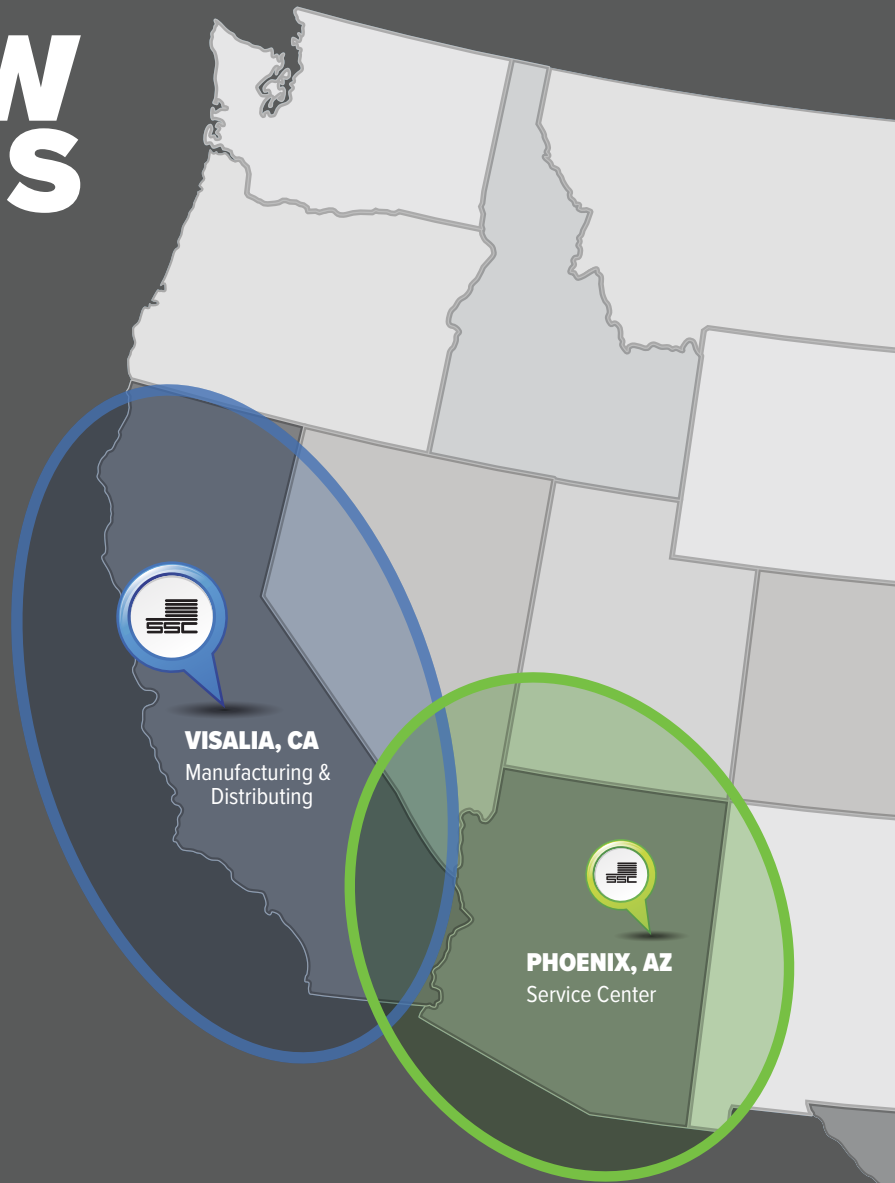

UPS GROUND SAME DAY SHIPPING GUARANTEED WHEN ORDERED BY 1 PM

UPS Air orders placed by 4:30pm EST Ship the Same Day Guaranteed

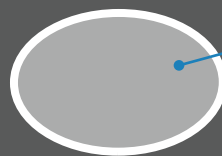

1 DAY SHIPPING ZONE

2 DAY SHIPPING ZONE

for the balance of the country. Call for details and exceptions.

Shipping zones are an average for the area. Depending on your specific location, UPS Ground might be one day longer. For the most up to date shipping information call SSC at **833.SSC.DOOR**.

2 SHIPPING ZONES

UPS GROUND SAME DAY SHIPPING GUARANTEED WHEN ORDERED BY 1 PM

UPS Air orders placed by 4:30pm EST Ship the Same Day Guaranteed

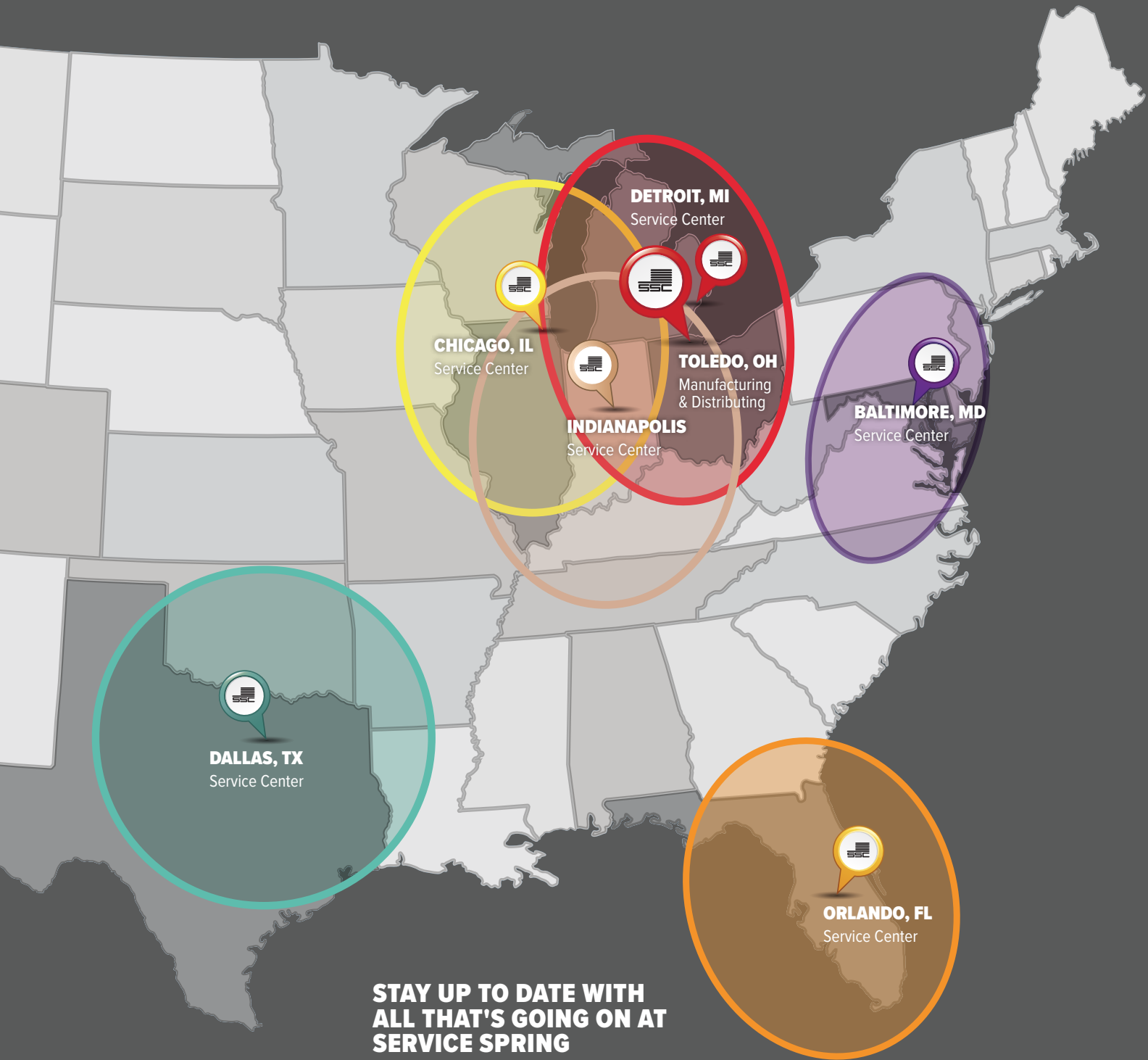

STAY UP TO DATE WITH ALL THAT'S GOING ON AT SERVICE SPRING

Follow SSC on social media! See pictures of the opening of service centers on Instagram and announcements on Twitter. PLUS! Watch for new videos on our YouTube channel or go to our website for how-to installs and tips for Springs.



MATT McALEAR, CEO

PARTNERSHIP

At SSC, we pride ourselves on being a world-class American manufacturer with an obsessive focus on providing unequaled customer service in the garage door industry. Part of our “Supplier-of-Choice” vision begins with challenging the status quo and setting the bar higher. We want to not only add value to you consistently but be a true partner to help your business grow and succeed.

With 9 locations throughout the US and growing, we are now even closer to you. By having a local presence, along with the fastest spring lead-times in the industry, our customers can pick up most orders the same day. This “One-Stop-Shop” strategy permits us to have everything you need, all under the convenience of one roof. Along with our online ordering platforms and mobile applications, we continue to simplify your life.

We are grateful to all our customers and appreciate the trust you’ve shown us. We will continue to work hard each day by focusing on adding value to you and our amazing industry!

Sincerely,

Matthew McAlear



UNIQUE DOORS

WE MAKE SPRINGS FOR ALL DIFFERENT TYPES OF DOORS!

- One-Piece Doors
- Dock Leveler
- Rolling Steel Doors
- Dry Freight/Truck
- Sectional
- Mini-Storage



DUPLEX & TRIPLEX

AS A SPRING MANUFACTURER, WE WILL GET YOU THE SPRING YOU NEED FOR ANY APPLICATION!

Call our Sales Team today to ask more about the benefits of Triplex and Duplex springs at **833.SSC.DOOR**

MANUFACTURING CAPABILITIES

ALL OUR SPRINGS HAVE THE OPTION FOR FREE CUSTOM STENCILING



BLACK COATED

- Clean surface - no oily mess or cleanup needed
- Enhanced corrosion resistance - keeps inventory stock looking "new"
- Printed wire diameter identification - easy stockroom identification
- Preprinted winding line - no need for chalk or paint during installation
- Coating is provided at no additional charge for springs up to 10" ID with maximum length of 240" *Some restrictions may apply*

SQUARE WIRE

- Improve cycle life within available shaft space
- Wire sizes: .312, .343, .375, .406, .437
- Available from our Toledo, Ohio location



GALVANIZED

- Wire sizes: .192, .207, .218, .225, .234, .243, .250, .262, .273, .283, .295
- Strong corrosion resistance
- Clean, shiny attractive finish
- Preprinted winding line
- 10 piece minimum of identical springs – same wind same size



MINI WAREHOUSE

- Specify hand wound, wire size, inside diameter, length and end type
- Manufactured to your specification



DOUBLE LOOPED 90° ENDS (DL) Standard on 200 lbs & under



OPEN LOOPED ENDS (OL)



POWDER COATED

- Provides a uniform, durable, high-quality finish
- Not available at all locations.
- Provides resistance to chipping, scratching, fading & wear
- Environmentally friendly, contains no solvents or VOC's
- Minimum Order - 25 pieces
- Lengths over 48" require additional charges
- Wide range of colors to choose from. Choose a custom color, or for faster turn-around, see stock colors shown above



CLIPPED ENDS (CL) Standard on 210 lbs & higher

Powder Coated Torsion Springs let you offer a premium spring to your customers. Springs are professionally powder coated with cones and individually poly bagged for protection, presenting customers with a newly finished look upon installation!

ADDITIONAL COST PER SPRING:

25 min. qty. \$9.99

EXTENSION SPRINGS

- Double, Single, Open Looped, Clipped Ends
- Coated for corrosion resistance
- Manufactured to your specification
- Available in "H" Style one-piece door springs



LEARN MORE

Scan this code to learn about TYPES OF WIRE by watching this video!

ORDERING INFORMATION

LIFE OF A SSC SPRING

MADE IN AMERICA TO MEET YOUR NEEDS



YOUR ORDER, OUR EXPERTS

EXPERIENCED, TECHNICAL SERVICE REPRESENTATIVES

- Answers to spring engineering questions
- Recommendations for add-on sales potential



YOUR ORDER IS RECEIVED

CUSTOM SOFTWARE INTEGRATES ORDERS FROM OUR SALES
TEAM TO OUR PRODUCTION LINES



SPRINGS ON THE LINE

STANDARD WIRE SIZES IN-STOCK, READY FOR YOUR ORDER

- Raw wire is loaded and begins the process
- Innovative software automates production

NEW LOCATIONS

SSC has locations all across the country to better serve you. Along with our two manufacturing locations, we have Service Centers who are able to cut springs to your desired length. Now pick-up at a location near you to receive items faster!



TAKING PRIDE IN PRESENTATION

PROVIDING A HIGH-QUALITY FINISH ON EVERY SPRING

- Springs are placed in a 'black coating' dip tank
- Springs are stamped with wire diameter and winder line. Custom messages are available for stamping!
- Cones are added to the springs as the final step of production before they are ready to ship!



LIFE OF A SPRING

7

HOW TO ORDER SPRINGS

TORSION SPRING ENDS

- 1. WINDING:** Right Hand or Left Hand
- 2. WIRE SIZE:** Use Spring Wire Gauge, or measure 10 or 20 coils to nearest $\frac{1}{16}$ " & refer to "Spring Wire Chart".
- 3. INSIDE DIAMETER:** Measure I.D. to nearest $\frac{1}{16}$ " and refer to "I.D. Chart".
Note: Manufacturers not listed on "I.D. Chart" probably use these I.D.s: $\frac{1}{4}$ ", 2", 2 $\frac{5}{8}$ ", 3 $\frac{3}{4}$ ", 5 $\frac{1}{4}$ ", or 6". These I.D.s may often be verified by locating corresponding numbers on the spring fittings. Example: "175" for $\frac{1}{4}$ " I.D., "200" for 2", "258" or "263" for 2 $\frac{5}{8}$ ", etc.
- 4. LENGTH OF SPRING WIRE:** Measure overall length of spring, or provide total number of coils in unwound length of spring.



Standard Torsion Spring End



Overhead Ends Up 2" ID



Wagner End $2\frac{1}{2}$ " ID



Mini Warehouse End Various ID's



Ends In McKee & Various ID's



Crawford T-Spring End $3\frac{25}{32}$ " ID



Crawford End $1\frac{19}{32}$ " & $2\frac{25}{32}$ " ID

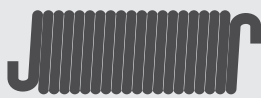

Barcol End $1\frac{13}{16}$ " ID



Rolling Steel Long End Various ID's

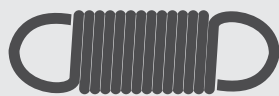

Rolling Steel Loops Various ID's

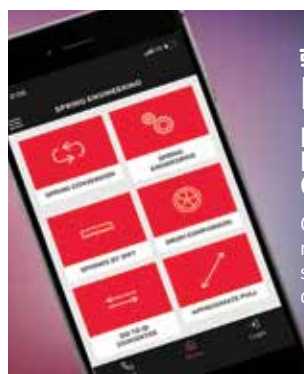
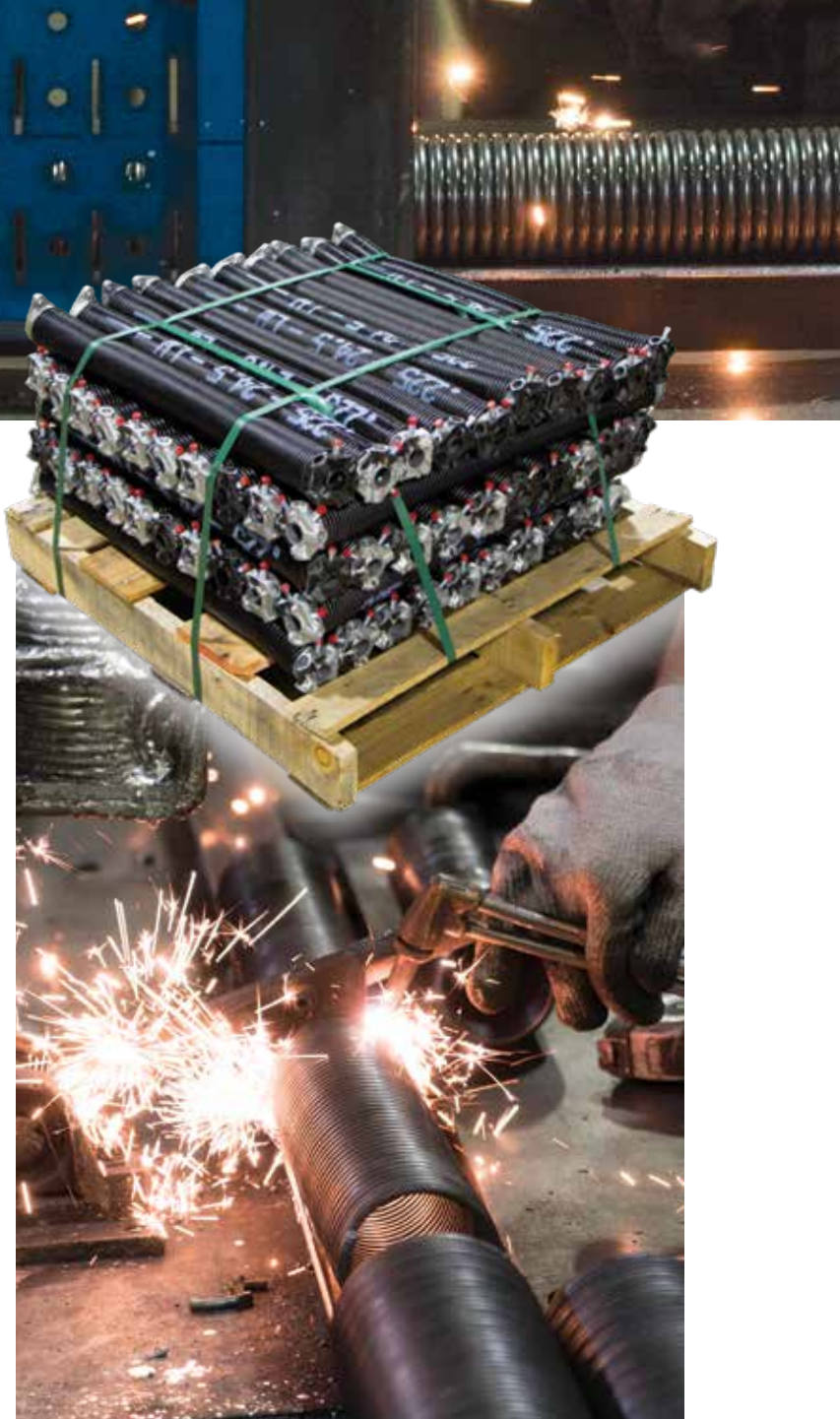

SSC SOLUTIONS ENGINEERING

DOWNLOAD THE SSC SPRING ENGINEERING APP BASED OFF OUR SPRING RATE BOOK

Our new user-friendly engineering app will make your SSC experience even better! Do spring conversions, engineering, compare drums and so much more!

Download our new app for Apple or Android today!

8 ORDERING INFORMATION



FORMULAS & RULES

ABOUT SPRING MEASUREMENTS



HOW TO MEASURE A SPRING
SCAN THE CODE TO WATCH THE VIDEO!

FORMULAS & RULES

COIL NUMBER
X WIRE SIZE
= **SPRING LENGTH**
Ex: 100 coils x .250 wire = 25"

OUTSIDE DIA.
- WIRE SIZE
- WIRE SIZE
= **SPRING ID**
Ex: 2½" - .250 - .250 = 2" ID

EXTENSION SPRINGS

DOOR HEIGHT
÷ TWO
= **SPRING STRETCH**
Ex: 7'H door, 84" / 2 = 42" stretch

HIGH LIFT is the measured distance from the top of a closed door to the center of the horizontal track

WHEN CONVERTING SPRINGS always convert to a spring of equal or greater wire diameter

TORSION SPRINGS

NUMBER OF TURNS
X WIRE SIZE
= **SPRING GROWTH**
Ex: 10 turns x .250 wire = 2½" growth

LENGTH OF 20 COILS
÷ NUMBER OF COILS
= **WIRE SIZE**
Ex: 5" per 20 coils, 5" / 20 = .250 wire

TOTAL IPPT
÷ DRUM MULTIPLIER
= **DOOR WEIGHT**
Ex: 1PR .250 x 2 x 32" installed on a 7' door with a 15" radius, 400-8 drums. IPPT is 41.5 per spring, multiplier is .2866. Total IPPT of 83 divided by .2866 = 289 lbs door weight

REQUIRED IPPT equals Door Weight x Hi Moment Arm divided by Number of Turns

DOOR WEIGHT equals IPPT x Number of Turns divided by Hi Moment Arm

EXTENSION SPRINGS

METHOD#1

- | | |
|-----------------------------|---------------------|
| 1. Furnish spring length | EXAMPLE: |
| 2. Amount of stretch | 25" - 42" - 150 lbs |
| 3. Pull of spring in pounds | |

METHOD#2

- | | |
|---|---|
| 1. Furnish wire size | EXAMPLE: |
| 2. Inside diameter or outside diameter to nearest 1/32" | .177-1 1/32" ID - 25" with Double Loops |
| 3. Length of spring (not including loops) | |
| 4. Type of ends | |
| 5. Specify if wound tight for a one-piece door | |

METHOD#3

- | | |
|--------------------------------|---------------------|
| 1. Furnish door width & height | EXAMPLE: |
| 2. Door weight | 8'W x 7'H x 150 lbs |

MADE TO ORDER

5 LBS MINIMUM CHARGE APPLIES TO ALL CUSTOM EXTENSION SPRINGS

Wire Sizes Under .3938 (sold per pound) \$
Wire Sizes .3938 & Larger (sold per pound) \$
Add Clips To Springs Under .207 Wire \$
Add Clips To Springs .207 & Larger \$

COMMON EXTENSION SPRING SIZES

HEIGHT	LENGTH	STRETCH	HEIGHT	LENGTH	STRETCH
6'6"	25"	39"	9'	36"	54"
7'	25"	42"	9'	39"	54"
7'	27"	42"	10'	44"	60"
7'	32"	42"	11'	48"	66"
7'6"	27"	45"	12'	53"	72"
8'	27"	48"	13'	57"	78"
8'	29"	48"	14'	60"	84"
8'	32"	48"			

ORDERING INFORMATION

All springs rated for a minimum of 10,000 cycles and are coated black. Additional charge to add clips.

All Pricing Subject To Change



SPRING WIRE CHART

Length of 10 Coils	Length of 20 Coils	Wire Size
1 1/4"	2 1/2"	.125
1 3/8"	2 3/4"	.135
1 7/16"	2 7/8"	.142
1 1/2"	3"	.1483
1 9/16"	3 1/8"	.1562
1 5/8"	3 1/4"	.162
1 11/16"	3 3/8"	.170
1 3/4"	3 1/2"	.177
1 7/8"	3 3/4"	.1875
1 15/16"	3 7/8"	.192
2 1/16"	4 1/8"	.207
2 3/16"	4 3/8"	.2187
2 1/4"	4 1/2"	.2253
2 5/16"	4 5/8"	.2343
2 7/16"	4 7/8"	.2437
2 1/2"	5"	.250
2 5/8"	5 1/4"	.2625
2 3/4"	5 1/2"	.273
2 13/16"	5 5/8"	.283
2 7/8"	5 3/4"	.289
2 15/16"	5 7/8"	.295
3 1/16"	6 1/8"	.3065
3 1/8"	6 1/4"	.3125
3 3/16"	6 3/8"	.3195
3 5/16"	6 5/8"	.331
3 7/16"	6 7/8"	.3437
3 5/8"	7 1/4"	.3625
3 3/4"	7 1/2"	.375
3 15/16"	7 7/8"	.3938
4 1/16"	8 1/8"	.4062
4 7/32"	8 7/16"	.4218
4 5/16"	8 5/8"	.4305
4 3/8"	8 3/4"	.4375
4 17/32"	9 1/16"	.4531
4 5/8"	9 1/4"	.4615
4 11/16"	9 3/8"	.4687
4 7/8"	9 3/4"	.490
5"	10"	.500
5 5/16"	10 5/8"	.5312
5 5/8"	11 1/4"	.5625
6 1/4"	12 1/2"	.625

SPRING ID

	BARCOL	CRAWFORD	MCKEE	OVERHEAD	RAYNOR	ROWE	WAGNER	MOST OTHERS	FITTINGS AVAILABLE FROM SSC
1 19/32"	●								No
1 3/4"		●	●			●		●	Yes
1 13/16"	●				●				No
2"		●	●					●	Yes
2 1/4"					●	●			Yes
2 7/16"			●						No
2 1/2"							●		No
2 5/8"	●	●						●	Yes
2 3/4"					●	●			No
2 25/32"	●								No
3"			●						No
3 3/8"			●						Yes
3 1/2"				●					Yes
3 3/4"								●	Yes
3 25/32"	●								No
4"							●		No
4 3/8"			●						No
4 1/2"	●	●							No
4 7/8"					●				No
5 1/4"								●	Yes
5 1/2"				●					Yes
5 3/4"	●								No
5 7/8"			●						Yes
6"	●	●						●	Yes
7 5/8"			●						Yes

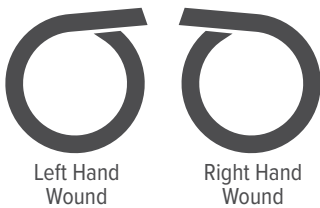

Left Hand Wound

Right Hand Wound

WHICH WIND

WIND DIRECTION vs. WHICH SIDE OF THE DOOR TO INSTALL YOUR SPRING

One of the most commonly misunderstood facts about the wind of a spring and the placement of the spring on the door, **SPRING WIND**—also known as wound, refers to the direction the wire is coiled to make the spring. The wind is helpful to know the direction the spring will uncoil as the door moves up and down. Cones will have threads that match your spring's wind.

A **LEFT HAND WOUND** spring is mounted on the right side of the door and a **RIGHT HAND WOUND** spring on the left. There are exceptions to this rule but this is recommended for engineering.

HELPFUL TRICK: Make an 'O' with your index finger and thumb. Using the tip of your finger as the end of the wire, follow the direction down your finger and it will give you the direction the spring is coiled.

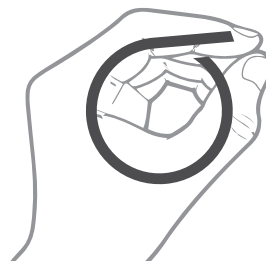

Left Hand Wound
Right Door Side

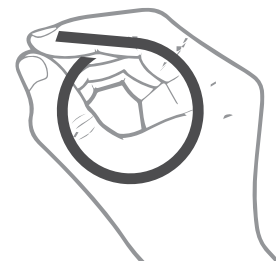

Right Hand Wound
Left Door Side

ONLY \$3⁸⁰
Have a reminder everywhere you go!
KEYSSC - WINDING CHART KEYCHAIN



LEARN MORE
Scan this code to learn how to find WHICH WIND by watching this video!



	1 ¹⁹ / ₃₂ "	1 ³ / ₄ "	2"	2 ¹ / ₄ "	2 ⁵ / ₈ "	2 ²⁵ / ₃₂ "	3 ³ / ₈ "	3 ¹ / ₂ "	3 ³ / ₄ "	5 ¹ / ₄ "	5 ¹ / ₂ "	5 ⁷ / ₈ "	6"	7 ⁵ / ₈ "
.1250	0.1500	0.1637	0.1855	0.2073	0.2401	0.2482	0.3055	0.3164	0.3383	0.4692	0.4910	0.5238	0.5347	0.6765
.1350	0.1630	0.1777	0.2013	0.2248	0.2602	0.2690	0.3309	0.3427	0.3662	0.5076	0.5312	0.5665	0.5783	0.7315
.1420	0.1712	0.1866	0.2113	0.2359	0.2729	0.2822	0.3469	0.3592	0.3839	0.5318	0.5565	0.5935	0.6058	0.7661
.1483	0.1804	0.1966	0.2225	0.2484	0.2872	0.2969	0.3649	0.3778	0.4037	0.5590	0.5849	0.6237	0.6367	0.8050
.1562	0.1910	0.2081	0.2353	0.2626	0.3036	0.3138	0.3854	0.3991	0.4263	0.5901	0.6173	0.6583	0.6719	0.8493
.1620	0.1986	0.2163	0.2446	0.2729	0.3153	0.3259	0.4001	0.4143	0.4425	0.6122	0.6405	0.6829	0.6971	0.8809
.1700	0.2138	0.2327	0.2630	0.2933	0.3387	0.3501	0.4296	0.4448	0.4751	0.6569	0.6872	0.7326	0.7478	0.9447
.1770	0.2189	0.2382	0.2691	0.3000	0.3463	0.3579	0.4390	0.4545	0.4854	0.6707	0.7016	0.7480	0.7634	0.9643
.1875	0.2332	0.2537	0.2864	0.3191	0.3682	0.3805	0.4664	0.4828	0.5155	0.7119	0.7447	0.7938	0.8101	1.0229
.1920	0.2394	0.2604	0.2939	0.3274	0.3777	0.3902	0.4782	0.4950	0.5285	0.7296	0.7631	0.8134	0.8301	1.0480
.2070	0.2603	0.2829	0.3190	0.3552	0.4094	0.4229	0.5178	0.5359	0.5720	0.7889	0.8250	0.8792	0.8973	1.1322
.2187	0.2768	0.3007	0.3389	0.3771	0.4344	0.4487	0.5489	0.5680	0.6062	0.8353	0.8735	0.9308	0.9499	1.1981
.2253	0.2862	0.3108	0.3501	0.3895	0.4485	0.4632	0.5665	0.5861	0.6255	0.8615	0.9008	0.9598	0.9795	1.2351
.2343	0.2992	0.3248	0.3657	0.4067	0.4681	0.4834	0.5908	0.6113	0.6522	0.8978	0.9387	1.0001	1.0205	1.2865
.2437	0.3127	0.3393	0.3818	0.4243	0.4882	0.5041	0.6158	0.6370	0.6796	0.9348	0.9774	1.0412	1.0625	1.3390
.2500	0.3219	0.3491	0.3928	0.4364	0.5019	0.5182	0.6328	0.6546	0.6983	0.9601	1.0038	1.0692	1.0911	1.3747
.2625	0.3403	0.3689	0.4147	0.4606	0.5293	0.5465	0.6668	0.6897	0.7355	1.0105	1.0563	1.1251	1.1480	1.4459
.2730	0.3573	0.3872	0.4351	0.4829	0.5547	0.5726	0.6983	0.7222	0.7700	1.0572	1.1050	1.1768	1.2007	1.5118
.2830	0.3708	0.4017	0.4511	0.5005	0.5746	0.5931	0.7228	0.7475	0.7969	1.0933	1.1427	1.2168	1.2415	1.5626
.2890	0.3807	0.4123	0.4628	0.5134	0.5892	0.6081	0.7408	0.7661	0.8167	1.1199	1.1705	1.2463	1.2716	1.6002
.2950	0.3941	0.4267	0.4788	0.5310	0.6092	0.6288	0.7657	0.7918	0.8440	1.1569	1.2091	1.2873	1.3134	1.6524
.3065	0.4068	0.4402	0.4937	0.5472	0.6275	0.6476	0.7880	0.8148	0.8683	1.1894	1.2429	1.3232	1.3499	1.6978
.3125	0.4160	0.4501	0.5047	0.5592	0.6411	0.6615	0.8047	0.8320	0.8866	1.2139	1.2685	1.3503	1.3776	1.7323
.3195	0.4233	0.4579	0.5132	0.5685	0.6514	0.6722	0.8174	0.8450	0.9003	1.2322	1.2875	1.3705	1.3981	1.7576
.3310	0.4448	0.4809	0.5387	0.5965	0.6832	0.7048	0.8565	0.8854	0.9432	1.2898	1.3476	1.4343	1.4632	1.8387
.3437	0.4652	0.5027	0.5627	0.6227	0.7128	0.7353	0.8928	0.9228	0.9829	1.3430	1.4030	1.4931	1.5231	1.9132
.3625	0.4952	0.5347	0.5980	0.6613	0.7562	0.7800	0.9461	0.9777	1.0410	1.4207	1.4840	1.5789	1.6106	2.0219
.3750	0.5156	0.5565	0.6219	0.6874	0.7856	0.8101	0.9820	1.0147	1.0802	1.4730	1.5385	1.6367	1.6694	2.0950
.3938	0.5465	0.5895	0.6582	0.7269	0.8301	0.8558	1.0363	1.0707	1.1394	1.5518	1.6206	1.7237	1.7581	2.2049
.4062	0.5674	0.6117	0.6827	0.7536	0.8600	0.8866	1.0728	1.1082	1.1792	1.6047	1.6757	1.7821	1.8175	2.2786
.4218	0.5938	0.6399	0.7135	0.7872	0.8977	0.9253	1.1187	1.1555	1.2292	1.6711	1.7448	1.8552	1.8921	2.3709
.4305	0.6085	0.6555	0.7306	0.8058	0.9185	0.9466	1.1439	1.1815	1.2567	1.7076	1.7827	1.8954	1.9330	2.4215
.4375	0.6205	0.6682	0.7446	0.8210	0.9355	0.9642	1.1647	1.2028	1.2792	1.7374	1.8138	1.9284	1.9665	2.4630
.4531	0.6476	0.6971	0.7762	0.8553	0.9739	1.0036	1.2112	1.2508	1.3299	1.8045	1.8836	2.0022	2.0418	2.5559
.4615	0.6623	0.7127	0.7933	0.8738	0.9947	1.0249	1.2364	1.2767	1.3572	1.8407	1.9212	2.0421	2.0824	2.6061
.4687	0.6752	0.7263	0.8082	0.8900	1.0128	1.0435	1.2583	1.2993	1.3811	1.8722	1.9540	2.0768	2.1177	2.6497
.4900	0.7130	0.7664	0.8520	0.9375	1.0658	1.0979	1.3224	1.3652	1.4507	1.9640	2.0495	2.1778	2.2206	2.7766
.5000	0.7310	0.7856	0.8728	0.9601	1.0911	1.1238	1.3529	1.3965	1.4838	2.0075	2.0948	2.2257	2.2694	2.8367
.5312	0.7884	0.8464	0.9391	1.0319	1.1710	1.2058	1.4493	1.4956	1.5884	2.1449	2.2377	2.3768	2.4232	3.0261
.5625	0.8469	0.9083	1.0065	1.1047	1.2520	1.2888	1.5465	1.5956	1.6938	2.2830	2.3812	2.5285	2.5776	3.2158
.6250	0.9684	1.0366	1.1457	1.2549	1.4185	1.4594	1.7459	1.8005	1.9096	2.5643	2.6734	2.8371	2.8916	3.6009



DOWNLOAD FORM

SPRING WEIGHT CHART PER INCH

- To determine spring weight: Locate "Weight per Inch" factor on the chart and multiply by the spring length (inches).
- Example: To determine weight of .2437 x 2 x 28.5, multiply .3818 (from chart) x 28.5 = 10.88 lbs.

All Pricing Subject To Change

2" ID STANDARD POWDER COATING



SSC NOW STOCKS POPULAR SPRINGS WITH A RED POWDER COATING.

We're bringing you the benefits of powder coating with the convenience of being in-stock & ready to ship!

RHW	LHW	WIRE	ID	LN	WT	IPPT
SPC21829R	SPC21829L	0.2187	2	29.00	10.43	23.8
SPC2252975R	SPC2252975L	0.2253	2	29.75	11.02	26.8
SPC2343225R	SPC2343225L	0.2343	2	32.25	12.39	29.8
SPC243355R	SPC243355L	0.2437	2	35.50	14.15	32.8
SPC25037R	SPC25037L	0.2500	2	37.00	15.13	35.8
SPC2624325R	SPC2624325L	0.2625	2	43.25	18.54	38.7
SPC2624025R	SPC2624025L	0.2625	2	40.25	17.29	41.7
SPC2734525R	SPC2734525L	0.2730	2	45.25	20.29	44.7
SPC283505R	SPC283505L	0.2830	2	50.50	23.38	47.7
SPC283475R	SPC283475L	0.2830	2	47.50	22.03	50.7

- Provides a uniform, durable, high-quality finish
- Not available at all locations.
- Provides resistance to chipping, scratching, fading & wear
- Environmentally friendly, contains no solvents or VOC's
- Lengths over 48" require additional charges
- Wide range of colors to choose from. Choose a custom color or for faster turn-around see stock colors shown above

See page 5 for more options for powder coating.





LIFE'S FULL OF COLOR

Available in Ohio & California manufacturing locations



1³/₄" ID STANDARD TORSION SPRINGS

RHW	LHW	WIRE	LN	WT	IPPT	RHW	LHW	WIRE	LN	WT	IPPT
17070R	17070L	0.1920	20.00	5.9	20.8	23431R	23431L	0.2343	31.00	10.7	38.7
17090R	17090L	0.2070	22.50	7.0	26.6	23417532R	23417532L	0.2343	32.00	11.0	34.0
20717523R	20717523L	0.2070	23.00	7.1	26.0	23417529R	23417529L	0.2343	29.00	10.1	35.7
20724R	20724L	0.2070	24.00	7.4	24.9	17140R	17140L	0.2437	31.50	11.3	41.9
17080R	17080L	0.2070	25.00	7.7	23.8	81140R	81140L	0.2437	35.25	12.6	39.9
20731R	20731L	0.2070	31.00	9.4	19.1	24333R	24333L	0.2437	33.00	11.8	37.3
21817525R	21817525L	0.2187	25.00	8.1	31.3	24317535R	24317535L	0.2437	35.00	12.5	37.5
17100R	17100L	0.2187	26.25	8.5	29.7	24317536R	24317536L	0.2437	36.00	12.8	36.5
21817528R	21817528L	0.2187	28.00	9.0	27.8	24317538R	24317538L	0.2437	38.00	13.5	34.5
21817529R	21817529L	0.2187	29.00	9.3	26.8	17150R	17150L	0.2500	33.50	12.3	44.5
21831R	21831L	0.2187	31.00	10.0	25.0	25035R	25035L	0.2500	35.00	12.9	42.6
22517527R	22517527L	0.2253	27.00	9.0	33.41	25039R	25039L	0.2500	39.00	14.3	39.9
17110R	17110L	0.2253	27.50	9.2	32.8	26238R	26238L	0.2625	38.00	14.7	51.0
22517528R	22517528L	0.2253	28.00	9.3	32.2	81160R	81160L	0.2625	44.00	16.9	42.7
22529R	22529L	0.2253	29.00	9.7	31.0						
22517540R	22517540L	0.2253	40.00	13.0	22.2						



2" ID STANDARD TORSION SPRINGS

RHW	LHW	WIRE	LN	WT	IPPT	RHW	LHW	WIRE	LN	WT	IPPT
20070R	20070L	0.192	17.75	5.88	20.9	234231R	234231L	0.2343	31.00	11.94	31.2
82070R	82070L	0.192	19.75	6.4	18.6	82120R	82120L	0.2343	30.25	11.72	32.0
20090R	20090L	0.207	20	7.04	26.7	20140R	20140L	0.2437	28.25	11.45	41.7
207221R	207221L	0.207	21	7.3	25.4	243229R	243229L	0.2437	29.00	11.67	40.6
207222R	207222L	0.207	22	7.68	24.2	243230R	243230L	0.2437	30.00	12.05	39.2
207223R	207223L	0.207	23	7.94	23.1	2433025R	2433025L	0.2437	30.25	12.21	38.8
207224R	207224L	0.207	24	8.32	22.1	243231R	243231L	0.2437	31.00	12.44	37.8
82080R	82080L	0.207	24.75	8.56	21.4	82140R	82140L	0.2437	31.50	12.69	37.2
2072255R	2072255L	0.207	25.5	8.74	20.7	243232R	243232L	0.2437	32.00	12.88	36.6
207226R	207226L	0.207	26	8.89	20.3	243325R	243325L	0.2437	32.50	13.07	36.0
207228R	207228L	0.207	28	9.53	18.8	243233R	243233L	0.2437	33.00	13.20	35.5
218222R	218222L	0.2187	22	8.06	31.7	2432335R	2432335L	0.2437	33.50	13.39	34.9
218223R	218223L	0.2187	23	8.39	30.3	243234R	243234L	0.2437	34.00	13.58	34.4
218224R	218224L	0.2187	24	8.73	29.0	243345R	243345L	0.2437	34.50	13.77	33.9
2182245R	2182245L	0.2187	24.5	8.9	28.3	24336R	24336L	0.2437	36.00	14.40	32.4
2182475R	2182475L	0.2187	24.75	9.05	28.0	243237R	243237L	0.2437	37.00	14.73	31.5
218225R	218225L	0.2187	25	9.07	27.7	243239R	243239L	0.2437	39.00	15.49	29.8
82100R	82100L	0.2187	26	9.47	26.6	25028R	25028L	0.2500	28.00	11.66	47.7
218227R	218227L	0.2187	27	9.75	25.6	250229R	250229L	0.2500	29.00	11.99	46.0
218228R	218228L	0.2187	28	10.09	24.7	250231R	250231L	0.2500	31.00	12.78	42.9
218285R	218285L	0.2187	28.5	10.32	24.2	250233R	250233L	0.2500	33.00	13.56	40.2
218230R	218230L	0.2187	30	10.77	22.9	82150R	82150L	0.2500	33.25	13.72	39.9
225224R	225224L	0.2253	24	9	33.5	250234R	250234L	0.2500	34.00	13.95	39.0
225225R	225225L	0.2253	25	9.35	32.1	25036R	25036L	0.2500	36.00	14.80	36.7
225255R	225255L	0.2253	25.5	9.59	31.5	250238R	250238L	0.2500	38.00	15.53	34.7
225265R	225265L	0.2253	26.5	9.94	30.2	20170R	20170L	0.2625	33.50	14.55	50.3
82110R	82110L	0.2253	27.25	10.2	29.4	20160R	20160L	0.2625	35.50	15.38	47.4
225275R	225275L	0.2253	27.5	10.11	29.1	262236R	262236L	0.2625	36.00	15.53	46.7
225228R	225228L	0.2253	28	10.4	28.6	262365R	262365L	0.2625	36.50	15.80	46.1
225229R	225229L	0.2253	29	10.75	27.5	82170R	82170L	0.2625	37.00	16.01	45.4
225230R	225230L	0.2253	30	11.1	26.6	262238R	262238L	0.2625	38.00	16.36	44.2
225305R	225305L	0.2253	30.5	11.34	26.1	262239R	262239L	0.2625	39.00	16.84	43.0
225231R	225231L	0.2253	31	11.45	25.7	82160R	82160L	0.2625	39.25	16.94	42.7
225236R	225236L	0.2253	36	13.2	22.0	262240R	262240L	0.2625	40.00	17.19	41.9
20130R	20130L	0.2343	25.25	9.9	38.6	262241R	262241L	0.2625	41.00	17.60	40.8
234226R	234226L	0.2343	26	10.11	37.4	20190R	20190L	0.273	36.00	16.32	56.7
234227R	234227L	0.2343	27	10.48	36.0	273238R	273238L	0.273	38.00	17.13	53.6
20120R	20120L	0.2343	27.25	10.63	35.6	82190R	82190L	0.273	40.00	18.06	50.8
23429R	23429L	0.2343	29	11.27	33.4	273243R	273243L	0.273	43.00	19.31	47.1
234230R	234230L	0.2343	30	11.57	32.2	295243R	295243L	0.295	43.00	21.19	68.95
						29524775R	29524775L	0.295	47.75	23.46	61.87

ALL TORSION SPRING DASMA COLORS

148	BROWN	2343	BROWN	3125	TAN	4305	BROWN
156	TAN	2437	GREEN	3195	GREEN	4375	TAN
162	GREEN	250	GOLD	331	GOLD	4531	GREEN
177	GOLD	2625	BLUE	3437	BLUE	4615	GOLD
1875	BLUE	273	ORANGE	3625	ORANGE	4687	BLUE
192	ORANGE	283	LT. BLUE	375	LT. BLUE	490	LT. BLUE
207	YELLOW	289	YELLOW	3938	YELLOW	500	YELLOW
2187	WHITE	295	WHITE	4062	WHITE	5312	WHITE
2253	RED	3065	BROWN	4218	RED	5625	RED



**TORSION
SPRINGS**

Assembled with cones.

All Pricing Subject To Change



LARGE ID- LONG LENGTH TORSION SPRINGS



1 3/4" LONG LENGTH COATED - 120"

RHW	LHW	WIRE	ID	WT
17192R	17192L	.1920	1.75	31.24
17207R	17207L	.2070	1.75	33.95
17218R	17218L	.2187	1.75	36.09
17225R	17225L	.2253	1.75	37.29
17234R	17234L	.2343	1.75	38.98
17243R	17243L	.2437	1.75	40.71
17250R	17250L	.2500	1.75	41.90
17262R	17262L	.2625	1.75	44.27
17273R	17273L	.2730	1.75	46.47
17283R	17283L	.2830	1.75	47.47



2" LONG LENGTH COATED - 120"

RHW	LHW	WIRE	ID	WT
20192R	20192L	.1920	2.00	35.26
20207R	20207L	.2070	2.00	38.29
20218R	20218L	.2187	2.00	40.67
20225R	20225L	.2250	2.00	42.01
20234R	20234L	.2343	2.00	43.89
20243R	20243L	.2437	2.00	45.82
20250R	20250L	.2500	2.00	47.13
20262R	20262L	.2625	2.00	49.77
20273R	20273L	.2730	2.00	52.21
20283R	20283L	.2830	2.00	54.13
20295R	20295L	.2950	2.00	57.46



BORN ^{IN} THE ★ USA

QUALITY SPRINGS MADE IN THE USA.

At SSC, we manufacture quality garage door springs for both residential and commercial use, right here in the USA. With 9 locations throughout the United States, we strive to offer superior, super-fast service, by being closer to you.

SSC Quality and Service: Born in the USA.



servicespring.com | 833.SSC.DOOR



DOUBLE LOOPED 90° ENDS (DL) Standard on 200 lbs & under



OPEN LOOPED ENDS (OL)



CLIPPED ENDS (CL) Standard on 210 lbs & higher



H-STYLE FOR ONE-PIECE DOORS

• Shipping from California location and are excluded from Stock Spring Program

PART P728C (first image)

PART P328C (fourth image)

PART P528C (second image)

PART SL728 (fifth image)

PART P928C (third image)



TAYLOR SECTIONAL SPRING 16 X 7

PART 218

.2187 x 1.53" x 29" Taylor Sectional Wound Loose (OL)

ALL EXTENSION SPRING DASMA COLORS

10# WHITE	110# WHITE	210# WHITE
20# GREEN	120# GREEN	220# GREEN
30# YELLOW	130# YELLOW	230# YELLOW
40# BLUE	140# BLUE	240# BLUE
50# RED	150# RED	250# RED
60# BROWN	160# BROWN	260# BROWN
70# ORANGE	170# ORANGE	270# ORANGE
80# GOLD	180# GOLD	280# GOLD
90# LT. BLUE	190# LT. BLUE	290# LT. BLUE
100# TAN	200# TAN	300# TAN



- Combine any STOCK EXTENSION SPRING to achieve your best quantity pricing
- Coated, oil tempered wire
- Springs are stenciled and color coded for easy identification



7' HIGH (25-42)
CLIPPED ENDS (CL)

PART	PULL	END
108CL	80	CL
109CL	90	CL
110CL	100	CL
111CL	110	CL
112CL	120	CL
113CL	130	CL
114CL	140	CL
115CL	150	CL
116CL	160	CL



7' HIGH (25-42)
OPEN LOOPS (OL)

PART	PULL	END
1080	80	OL
1090	90	OL
1100	100	OL
1110	110	OL
1120	120	OL
1130	130	OL
1140	140	OL
1150	150	OL
1160	160	OL



7' HIGH (25-42)
DOUBLE LOOPS (DL/CL)

PART	PULL	END
104	40	DL
105	50	DL
106	60	DL
107	70	DL
108	80	DL
109	90	DL
110	100	DL
111	110	DL
112	120	DL
113	130	DL
114	140	DL
115	150	DL
116	160	DL
117	170	DL
118	180	DL
119	190	DL
120	200	DL
121	210	CL
122	220	CL



8' HIGH (27-48)
DOUBLE LOOPS (DL/CL)

PART	PULL	END
8107	70	DL
8108	80	DL
8109	90	DL
8110	100	DL
8111	110	DL
8112	120	DL
8113	130	DL
8114	140	DL
8115	150	DL
8116	160	DL
8117	170	DL
8118	180	DL
8119	190	DL
8120	200	DL
8121	210	CL
8122	220	CL



EXTENSION SPRING

All springs rated for a minimum of 10,000 cycles and are coated black. Add only a small additional fee per spring for clips on any 25-42s or 27-48s.

All Pricing Subject To Change



COVER PROMOTES SAFETY

• Restricts access to winding holes and set screws on 1 3/4" and 2" fittings

PART 985
Winding Cone Cover
500 pieces



1 3/4" 1/2" SET OR INDIVIDUALLY

• Maximum wire size: .295

PART 1300
Universal 2 Piece
Cone Set 1

PART 130
Winding Cone (left image) 1

PART 160
Stationary Cone (right image) 1



2" 1/2" SET OR INDIVIDUALLY

• Maximum wire size: .3065

PART 1320
Universal 2 Piece
Cone Set 1

PART 132
Winding Cone (left image) 1

PART 162
Stationary Cone (right image) 1



2 1/4" 1/2" SOLD AS SETS

• Maximum wire size: .3125

PART 189925
Right Wind 2 Piece Cone
Set - Raynor

PART 189926
Left Wind 2 Piece Cone
Set - Raynor

1 25
50 100



2 5/8" 1/2" SET OR INDIVIDUALLY

• Maximum wire size: .331

PART 1340
Universal 2 Piece Cone Set 1

PART 134
Winding Cone (left image) 1

PART 164
Stationary Cone (right image) 1



3 3/8" 5/8" SOLD AS SETS

• Maximum wire size: .375

PART 338R
Universal 2 Piece Cone, Red - OHD

PART 338L
Universal 2 Piece Cone, Black - OHD
1 25 50



3 1/2" 5/8" SOLD INDIVIDUALLY

• Maximum wire size: .4375

PART 138
Right Wind Winding
Cone - Raynor

PART 139
Left Wind Winding
Cone - Raynor 1



PART 148
Right Wind Stationary
Cone - Raynor

PART 149
Left Wind Stationary
Cone - Raynor 1



WINDING BAR FIT

For a quick reference on which diameter WINDING BAR fits each cone, look for one of these symbols.



See page 132 for more information on winding bars.



3 3/4"

5/8

SET OR INDIVIDUALLY

• Maximum wire size: .4062

PART 1360

Universal 2 Piece Cone Set

1 10
25 50

PART 195185

Universal Winding Cone (left image)

1 10
25 50

PART

Universal Stationary Cone (right image)

1 10
25 50



5/8

PART 195188

Universal Winding Cone
1 1/4" Bore

1



PART 193593

Right Wind Short Ear
Duplex Stationary Cone

1

PART 193592

Left Wind Short Ear
Duplex Stationary Cone

1



5 1/4"

5/8

SOLD INDIVIDUALLY

• Maximum wire size: .4375

PART 141U

Universal Winding Cone (left image)

1 5 10

PART 168U

Universal Stationary Cone (right image)

1 5 10



5 1/2"

3/4

SOLD INDIVIDUALLY

• Maximum wire size: .4375

PART 1512

Right Wind Winding
Cone - Raynor

PART 1513

Left Wind Winding
Cone - Raynor

1



PART 1516

Right Wind Stationary Cone Raynor

PART 1517

1



5 7/8"

5/8

SOLD INDIVIDUALLY

• Maximum wire size: .453

PART 1578

Right Wind Winding Cone - OHD

PART 1579

Left Wind Winding Cone
OHD

1

PART 1580

Right Wind Winding Cone - 1 1/4" Bore

PART 1581

Left Wind Winding Cone
1 1/4" Bore

1



PART 1582

Right Wind Stationary
Cone - OHD

PART 1583

Left Wind Stationary
Cone - OHD

1



6"

5/8

SET OR INDIVIDUALLY

• Maximum wire size: .4375

PART 1420R

Right-Hand Winding and Stationary
Cone Set - 1" Bore

PART 1440L

Left-Hand Winding and Stationary
Cone Set - 1" Bore

1

PART 1430R

Right Wind Winding and Stationary
Cone Set - 1 1/4" Bore

PART 1450L

Left Wind Winding and Stationary
Cone Set - 1 1/4" Bore

1

PART 142

Right Wind Winding Cone (left image)

PART 144

Left Wind Winding Cone

1 \$15.58

PART 143

Right Wind Winding Cone - 1 1/4" Bore

PART 145

Left Wind Winding Cone - 1 1/4" Bore

1 5 10

PART 170

Right Wind Stationary Cone
(right image)

PART 171

Left Wind Stationary Cone

1 5 10



7 1/4"

5/8

SOLD AS SETS

• Maximum wire size: .4375

PART 150

Triplex 2 Piece Spring Kit

1 6

PART 154

Triplex 2 Piece Spring Kit - 1 1/4" Bore

1 6



7 5/8"

3/4

SOLD INDIVIDUALLY

• Maximum wire size: .500

PART 152

Right Wind Winding Cone - OHD

PART 158

Left Wind Winding Cone - OHD

PART 153

Right Wind Winding Cone - OHD 1 1/4"

PART 159

Left Wind Winding Cone
OHD 1 1/4"

1

PART 174

Right Wind Stationary Cone - OHD

PART 175

Left Wind Stationary
Cone - OHD

1

SPRING FILLER

FOR USE WITH 1" OR 1 1/4" SHAFT

• Round filler helps reduce spring chatter for quieter door operation

• Fits 5 1/4" - 6" inside diameter

PART PSF425FT
PVC Spring Filler

PART PSF4258
PVC Spring Filler - 8'L

1 5 10

PART PSF42512
PVC Spring Filler - 12'L

1 5 10

PART PSF600FT
PVC Spring Filler 7 5/8"

PART PSF60012
PVC Spring Filler 7 5/8" - 12'L

1 5 10



LEARN MORE

Scan this code to learn how to CUT & CONE A SPRING by watching this video!



Scan this code to learn how to INSTALL SPRING FILLER by watching this video!

STATIONARY & WINDING CONES & SPRING FILLER

All Pricing Subject To Change



STANDARD LIFT

SOLD IN PAIRS

- Maximum door height: 8'
- Capacity: 265 lbs per drum
- Maximum cable size: 1/8"
- Cable length: Floor to shaft center +8"
- Cross Reference: Apco 400-8, DNS 4X 8, OMI 8', M102-2400

PART 180

D400-96 (8') Standard Lift

1 10 100

- Maximum door height: 12'
- Capacity: 375 lbs per drum
- Maximum cable size: 5/32"
- Cable length: Floor to shaft center +8"
- Cross Reference: Apco 400-12, DNS 4-13, OMI 12', M102-3670

PART 181

D400-144 (12') Standard Lift

1 10 100

- Maximum door height: 19'-3"
- Capacity: 750 lbs per drum
- Maximum cable size: 3/16"
- Cable length: Floor to shaft center +10"
- Cross Reference: Apco 5250-18, DNS 5-18, OMI 18', M134-5500

PART 183

D525-216 (19'-3") Standard Lift

1 6 30

PART 184

D525-216 (19'-3") Standard Lift

1/4" Bore 1

- Maximum door height: 32'
- Capacity: 1,100 lbs per drum
- Maximum cable size: 1/4"
- Cable length: Floor to shaft center +14"
- Cross Reference: Apco 800-32, DNS 402-32, OMI 32', M203-9750

PART 185

D800-384 (32') Standard Lift

1 5

PART 186

D800-384 (32') Standard Lift

1/4" Bore 1 5



HI - LIFT

SOLD IN PAIRS

- Maximum Hi-Lift: 54"
- Capacity: 275 lbs per drum
- Maximum cable size: 5/32"
- Cable length: Floor to shaft center +63" minus amount of hi-lift
- Cross Reference: Apco 400-54, DNS 54 LC, OMI 54 HL-LD, M102-1375

PART 190

D400-54 Hi-Lift

1 5 40

- Maximum Hi-Lift: 54"
- Capacity: 500 lbs per drum
- Maximum cable size: 3/16"
- Cable length: Floor to shaft center +66" minus amount of hi-lift
- Cross Reference: Apco 5250-54, DNS 54, OMI 54 HL, M134-1375

PART 191

D525-54 Hi-Lift

1 5 25

PART 193

5250-54 Hi-Lift - 1/4" Bore 1

- Maximum Hi-Lift: 120"
- Capacity: 500 lbs per drum
- Maximum cable size: 3/16"
- Cable length: Floor to shaft center +133" minus amount of hi-lift
- Cross Reference: Apco 5750-120, DNS 120, OMI 120 HL, M146-3050

PART 192

D575-120 Hi-Lift

1 4 16

PART 194

D575-120 Hi-Lift - 1/4" Bore 1

- Maximum Hi-Lift: 164"
- Capacity: 800 lbs per drum
- Maximum cable size: 1/4"
- Cable length: Floor to shaft center +181" minus amount of hi-lift
- Cross Reference: Apco 6375-164, DNS 410-164, OMI 164 HL, M162-4165

PART 195

D6375-164 Hi-Lift

1 8

PART 196

D6375-164 Hi-Lift - 1/4" Bore

1 8



VERTICAL LIFT

SOLD IN PAIRS

- Maximum Hi-Lift: 120"
- Capacity: 1,100 lbs per drum
- Maximum cable size: 1/4"
- Cable length: Floor to shaft center +137" minus amount of hi-lift
- Cross Reference: M203-3050

PART 220

D800-120 Hi-Lift

1

PART 221

D800-120 Hi-Lift - 1/4" Bore 1

- Maximum door height: 11'
- Capacity: 425 lbs per drum
- Maximum cable size: 3/16"
- Cable length: Floor to shaft center +143" minus door height
- Cross Reference: Apco 850-11, DNS 143-11, OMI 11 VL, M216-3350

PART 200

D850-132 (11') Vertical Lift

1 5 20

- Maximum door height: 18'
- Capacity: 660 lbs per drum
- Maximum cable size: 3/16"
- Cable length: Floor to shaft center +237" minus door height
- Cross Reference: Apco 1100-18, DNS 236-18, OMI 18 VL, M280-5500

PART 201

D1100-216 (18') Vertical Lift

1 5 20

PART 201A

D1100-216 (18') Vertical Lift

1/4" Bore 1

- Maximum door height: 28'
- Capacity: 1,100 lbs per drum
- Maximum cable size: 1/4"
- Cable length: Floor to shaft center +352" minus door height
- Cross Reference: Apco 1350-28, M340-8500

PART 202

D1350-336 (28') Vertical Lift

1

PART 203

D1350-336 (28') Vertical Lift

1/4" Bore 1

- Combine any in-stock CABLE DRUM for best quantity pricing
- All Cables Drums are sold as pairs



HARDWARE

PART 424

1/4" x 2 1/2" S-Hook
1 100

PART 137814

1 25 100

- Maximum spring OD 2 3/8"
- Set includes 8 plates, nuts and bolts

PART 421 Tandem Hookup Kit

1 10

- (1) PR cables, 1/8" 7x7 - 126", (2) 3" restraint forks, (2) Open eye bolts, 5/16" x 4", (2) Bend lacing clips, (2) Lag bolts 5/16" x 1 5/8", (2) 3/8" x 1 1/2" machine bolts with nuts and washers
- For use on 7' and 8'H doors



PART 426

5/16" x 3 1/2" Open Eye Bolt
1 100



PART 423

Cable Adjustment Clip
1 100

PART 4200

Extension Spring Containment Kit
1 10 100



PULLEY

- 100 lbs at 10,000 8' door cycles

PART 300

3" Pulley - 3/8" Bore
1 25 50
▶Fasteners sold separately



PART 301

3" Clevis Pulley
1 25 50
▶Includes 3/8-16 x 1-1/4" bolts, nut & fork



- 400 lbs at 10,000 8' door cycles

PART 134870

3" Cast Pulley with Precision Bearings
1 25 250
50



FORK

FASTENERS SOLD SEPARATELY

PART 302

3" Fork
1 25 1000
▶Attach with 3/8-16 x 1 1/4" bolt & nut



- Heavy wall gold
- 200 lbs at 10,000 8' door cycles

PART 390

3" Heavy Wall Pulley - 3/8" Bore
1 15 60
▶Fasteners sold separately



PART 391

3" Heavy Wall Clevis Pulley
1 15 60
▶Includes 3/8-16 x 1 1/4" bolt, nut & 3" fork



- Fixed Stud
- Nuts not included
- 200 lbs at 35,000 12' door cycles

PART 823

4" Stud Pulley
1 25 50



PART 305

4" Fork
1 25 200
▶Attach with 3/8-16 x 1 3/4" bolt & nut



- 200 lbs at 35,000 12' door cycles

PART 303

4" Pulley - 3/8" Bore
1 25 100
▶Fasteners sold separately



PART 304

4" Clevis Pulley
1 25 100
▶Includes 3/8-16 x 1 3/4" bolts, nut & fork



- Removable stud
- 400 lbs at 35,000 12' door cycles

PART 821

5" Cast Pulley - 5/8" Bore
1 10 25



- Nylon bushing for restraint cable
- 14 Gauge

PART 344

3" Restraint Fork
1 25 300

HARDWARE PULLEYS & FORKS



7 x 7
7 strands
7 wires/strand

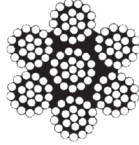

7 x 19
7 strands
19 wires/strand



PREMIUM CABLE

SOLD INDIVIDUALLY

PART 294PREM

500' Reel 1/8" 7 x 19 2,000 lbs
1 6 10

PART 295PREM

500' Reel 5/32" 7 x 19 2,800 lbs
1 6 10

PART 296PREM

500' Reel 3/16" 7 x 19 4,200 lbs
1 6 10

PART 297PREM

500' Reel 1/4" 7 x 19 7,000 lbs
1 6 10

TORSION

PART 457PREM

8'6" 1/8" 7 x 19 Red
1 25 50

PART 458PREM

9'6" 1/8" 7 x 19 Blue
1 25 50

PART 459PREM

8'6" 1/8" 7 x 7 Black
1 25 50

PART 460PREM

1/8" 7 x 7 9'6" Green
1 25 50

EXTENSION

PART 406PREM

12' 1/8" 7 x 19 Purple
1 25 50

PART 456PREM

13' 1/8" 7 x 19 Gray
1 25 50

TORSION PAIRS WITH FLOATING STOP UP TO 14' HIGH

PART 532193FS 7 x 19 16' 1"
Premium Torsion Cable 5/32" Brown
1 25 50

PART 316193FS 7 x 19 16' 1"
Premium Torsion Cable 3/16" Clear
1 25 50

TORSION PAIRS WITH FLOATING STOP UP TO 12' HIGH

PART 18183FS 7 x 19 15' 3"
Premium Torsion Cable 1/8" Blue
1 25 50



REEL OF CABLE

SOLD INDIVIDUALLY

293	3/32" 7 x 19	500'	1,000 lbs	1	6	10
298	3/32" 7 x 7	500'	920 lbs	1	6	10
299	1/8" 7 x 7	500'	1,700 lbs	1	6	10
294	1/8" 7 x 19	500'	2,000 lbs	1	6	10
400	1/8" 7 x 19	1,000'	2,000 lbs	1	6	10
295	5/32" 7 x 19	500'	2,800 lbs	1	6	10
296	3/16" 7 x 19	500'	4,200 lbs	1	6	10
297	1/4" 7 x 19	500'	7,000 lbs	1	6	10
2971	1/4" 7 x 19	100'	7,000 lbs	1	6	10



LEFT LAY REEL OF CABLE

SOLD INDIVIDUALLY

32756	1/8" 7 x 19	500'	2,000 lbs	1	6	10
32759	5/32" 7 x 19	500'	2,800 lbs	1	6	10
32761	3/16" 7 x 19	500'	4,200 lbs	1	6	10



CABLE ASSEMBLIES

SOLD IN PAIRS

7' H & 8' H TORSION SPRING DOORS

459	1/8" 7 x 7	8' 6"	Black	1	25	75
457	1/8" 7 x 19	8' 6"	Red	1	25	75
460	1/8" 7 x 7	9' 6"	Green	1	25	75
458	1/8" 7 x 19	9' 6"	Blue	1	25	75

7' H & 8' H EXTENSION SPRING DOORS

405	1/8" 7 x 7	12' 0"	Orange	1	25	75
406	1/8" 7 x 19	12' 0"	Purple	1	25	75
455	1/8" 7 x 7	13' 0"	Yellow	1	25	75
456	1/8" 7 x 19	13' 0"	Gray	1	25	75

RESTRAINT CABLES 7' & 8' H

454	3/32" 7 x 7	10' 0"	White	1	25	75
------------	-------------	--------	-------	---	----	----



STAINLESS STEEL CABLE

Stainless steel cable reels and cable assemblies are 304 grade.

REEL - SOLD INDIVIDUALLY

PART 18719250S

1/8" 7 x 19 250' 1,760 lbs
1 6 10

PART 18719500S

1/8" 7 x 19 500' 1,760 lbs
1 6 10

PART 532719250S

5/32" 7 x 19 250' 2,400 lbs
1 6 10

PART 532719500S

5/32" 7 x 19 500' 2,400 lbs
1 6 10

ASSEMBLIES - SOLD IN PAIRS

PART 457SS

1/8" 7 x 19 8' 6" Black
1 20 60

PART 458SS

1/8" 7 x 19 9' 6" Brown
1 20 60

BETTER & BEST

THE DIFFERENCE BETWEEN PREMIUM AND REGULAR CABLES

The cables we sell are high quality steel designed to give you long lasting durability. Our **PREMIUM CABLES** go one step further by providing a greater combination of unprocessed steel and a stronger bond.



SLEEVE

100 PIECES PER BAG

PART 318	3/32" Sleeve		
1	5	10	
PART 314	1/8" Sleeve		
1	5	10	
PART 315	5/32" Sleeve		
1	5	10	
PART 316	3/16" Sleeve		
1	5	10	
PART 317	1/4" Sleeve		
1	5	10	



STOP

100 PIECES PER BAG

PART 328	3/32" Stop		
1	5	10	
PART 324	1/8" Stop		
1	5	10	
PART 325	5/32" Stop		
1	5	10	
PART 326	3/16" Stop		
1	5	10	
PART 327	1/4" Stop		
1	5	10	



THIMBLE

100 PIECES PER BAG

PART 354	3/32" - 1/8" Thimble		
1	5	10	
PART 355	5/32" Thimble		
1	5	10	
PART 356	3/16" Thimble		
1	5	10	
PART 357	1/4" Thimble		
1	5	10	



CLAMP

100 PIECES PER BAG

PART 345	1/8" Clamp		
1	5	10	
PART 346	3/16" Clamp		
1	5	10	
PART 347	1/4" Clamp		
1	5	10	



QUIET HINGE KIT

COMPLETE SETS FOR 7' & 8' DOORS

Includes: 9 Hinges, 10 Roller Stem Silencer Sleeves, 10 Rollers, 10 Push Nuts, 100 3/8" Sheet Metal Screws

PART QUIET7S
Quiet Hinge Retrofit Kit for a 7' Single Car Garage Door

1	15	30
---	----	----

Includes: 11 Hinges, 12 Roller Stem Silencer Sleeves, 12 Rollers, 12 Push Nuts, 120 3/8" Sheet Metal Screws

PART QUIET8S
Quiet Hinge Retrofit Kit for a 8' Single Car Garage Door

1	15	30
---	----	----

Includes: 15 Hinges, 10 Roller Stem Silencer Sleeves, 10 Rollers, 10 Push Nuts, 152 5/8" Sheet Metal Screws

PART QUIET7D
Quiet Hinge Retrofit Kit for a 7' Double Car Garage Door

1	15	30
---	----	----

Includes: 20 Hinges, 12 Roller Stem Silencer Sleeves, 12 Rollers, 12 Push Nuts, 196 5/8" Sheet Metal Screws

PART QUIET8D
Quiet Hinge Retrofit Kit for a 8' Double Car Garage Door

1	15	30
---	----	----

Includes: 21 Hinges, 10 Roller Stem Silencer Sleeves, 10 Rollers, 10 Push Nuts, 200 5/8" Sheet Metal Screws

PART QUIET7DWL
Quiet Hinge Retrofit Kit for a 7' Double Wind Load Door

1	15	30
---	----	----

Includes: 28 Hinges, 12 Roller Stem Silencer Sleeves, 12 Rollers, 15 Push Nuts, 260 5/8" Sheet Metal Screws

PART QUIET8DWL
Quiet Hinge Retrofit Kit for a 8' Double Wind Load Door

1	15	30
---	----	----



QUIET HINGE

SOLD INDIVIDUALLY

• Silencer sleeve and push nut sold separately

PART QUIET1
#1 14 Gauge Quiet Hinge

1	25	90
---	----	----

PART QUIET2
#2 14 Gauge Quiet Hinge

1	25	90
---	----	----

PART QUIET3
#3 14 Gauge Quiet Hinge

1	25	72
---	----	----

PART QUIET4
#4 14 Gauge Quiet Hinge

1	25	54
---	----	----



• Compatible with Quiet Hinge only

PART SLEEVE
Silencer Sleeve in 50 packs with Push Nut

1		
---	--	--

PART QUIET5
#5 14 Gauge Quiet Hinge

1	25	54
---	----	----



• Combine any SLEEVES, THIMBLES, CLAMPS AND STOPS to achieve best quantity pricing.

CABLE FITTINGS & QUIET HINGE

All Pricing Subject To Change



11 GAUGE QUIET HINGE

PART 11QUIET1
#1 11 Gauge Quite Hinge
1 25 90

PART 11QUIET2
#2 11 Gauge Quite Hinge
1 25 90

PART 11QUIET3
#3 11 Gauge Quite Hinge
1 25 90

PART 11QUIET4
#4 11 Gauge Quite Hinge
1 25 90

PART 11QUIET5
#5 11 Gauge Quite Hinge
1 25 90

PART 11QUIET6
#6 11 Gauge Quite Hinge
1 25 90

PART 11QUIET7
#7 11 Gauge Quite Hinge
1 25 90

PART 11QUIET8
#8 11 Gauge Quite Hinge
1 25 90

PART 11QUIET9
#9 11 Gauge Quite Hinge
1 25 90



11 GAUGE

PART 491 #1 11 Gauge
1 25 75

PART 492 #2 11 Gauge
1 25 50

PART 493 #3 11 Gauge
1 25 50

PART 494 #4 11 Gauge
1 25 50

PART 495 #5 11 Gauge
1 25 50

PART 496 #6 11 Gauge
1 25 50

PART 247 #7 11 Gauge
1 25 50

PART 248 #8 11 Gauge
1 25 50

PART 249 #9 11 Gauge
1 25 50

PART 500 #10 11 Gauge
1 25 50

PART 501 #11 11 Gauge
1 25 50

PART 502 #12 11 Gauge
1 25 50



14 GAUGE

PART 241 #1 14 Gauge
1 25 100

PART 242 #2 14 Gauge
1 25 100

PART 243 #3 14 Gauge
1 25 100

PART 244 #4 14 Gauge
1 25 100

PART 245 #5 13 Gauge
1 25 50

PART 246 #6 13 Gauge
1 25 50



18 GAUGE

PART 237 #1 18 Gauge
1 25 50

PART 238 #2 18 Gauge
1 25 100

PART 239 #3 18 Gauge
1 25 50

PART 240 #4 18 Gauge
1 25 100



14 GAUGE BLACK POWDER COATED

PART 230522 #1 14 Gauge
1 25 110

PART 230524 #2 14 Gauge
1 25 80

PART 230525 #3 14 Gauge
1 25 70

PART 230897 #4 14 Gauge
1 25 60



14 GAUGE NARROW RAIL

PART 250
14 Gauge 1/2 Hinge
1 25 175



16 GAUGE

PART 591 #1 16 Gauge
1 25 50

PART 592 #2 16 Gauge
1 25 50

PART 593 #3 16 Gauge
1 25 50

PART 594 #4 16 Gauge
1 25 50

LIKE THE BLACK POWDER COATED LOOK? THERE ARE MORE PRODUCTS!

We also have slide locks, top fixtures & bottom brackets in stock and ready to ship!

See page 28 for top fixtures & bottom brackets

See page 37 for Slide Locks

mix&match

• Combine any HINGES to achieve best quantity pricing



BLACK POWDER COATING



2" NYLON ROLLER

• Rating: 50 lbs per roller at 10,000 8' door cycles

PART 264

2" Nylon Roller - 4" Stem (no bearing)

1	200
400	1000



• Rating: 75 lbs per roller at 15,000 12' door cycles

PART 571

2" 11-Ball Nylon Roller - 4" Stem

1	150
300	1050

PART 572

2" 11-Ball Nylon Roller - 7" Stem

1	150
300	1050 \$1.34



PART 729

2" 13-Ball Nylon Roller - 4" Stem

1	100
200	1000

PART 732

2" 13-Ball Nylon Roller - 5" Stem

1	100
200	1000

PART 730

2" 13-Ball Nylon Roller - 7" Stem

1	100
200	1000

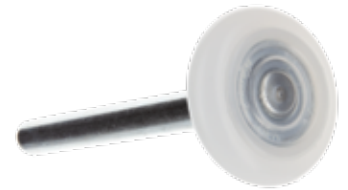

2" NYLON CAPPED ROLLER

• Rating: 125 lb per roller at 20,000 12' door cycles
• Solid clear nylon cap

PART 24CAP

2" 13-Ball Capped Nylon Roller - 4" Stem

PART 27CAP

2" 13-Ball Capped Nylon Roller - 7" Stem



2" NYLON ROLLER PRECISION BEARING

• Rating: 100 lb per roller at 100,000 12' door cycles

PART 186466

2" 6200 Shielded Precision Bearing Nylon Roller - 4" Stem

1	200	400
1000	2100	

PART 186471

2" 6200 Shielded Precision Bearing Nylon Roller - 7" Stem

1	150
300	1050

PART 186468

2" 6200 Shielded Precision Bearing Nylon Roller - 9" Stem

1	125
250	1000



2" STEEL ROLLER

• Rating: 35 lb per roller at 10,000 8' door cycles

PART 268

2" 7-Ball Steel Roller - 4" Stem

1	200
400	1000

• Rating: 75 lbs per roller at 15,000 12' door cycles

PART 265

2" 10-Ball Steel Roller - 4" Stem

1	200
400	1000

PART 266

2" 10-Ball Steel Roller - 7" Stem

1	150
300	1050

PART 547

2" 10-Ball Steel Roller - 9" Stem

1	100
200	1000



3" STEEL ROLLER

• Rating: 150 lbs per roller at 50,000 12' door cycles

PART 548

3" 10-Ball Steel Roller - 4" Stem

1	100	300
---	-----	-----

PART 267

3" 10-Ball Steel Roller - 7" Stem

1	75	300
---	----	-----

PART 269

3" 10-Ball Steel Roller - 9" Stem

1	40
80	1000

PART 722

3" 10-Ball Steel Roller - 11" Stem

1	25	67
---	----	----



2" CAR WASH PRECISION BEARING

• Rating: 100 lbs per roller at 100,000 12' door cycles
• Zinc Plated Stem

PART 549

2" Sealed Nylon Roller - 7" Stem

1	25	150
---	----	-----



3" CAR WASH PRECISION BEARING

• Rating: 150 lbs per roller at 100,000 12' door cycles
• Stainless steel stem

PART 569

3" Sealed Nylon Roller - 7 1/4" Stem

1	25	90
---	----	----



PART 570

3" Sealed Nylon Roller - 9" Stem

1	25	150
---	----	-----



- Combine any ROLLERS for best quantity pricing
- All Rollers have a 7/16" Shaft

ROLLERS



• 16 Gauge
PART 253
 Junior Adjustable Top Fixture
 1 25 100



• 12 Gauge
PART 254D
 Adjustable Top Fixture - Residential
 1 25 50



• 12 Gauge
PART 255
 Adjustable Top Fixture - Commercial
 1 25 50



• 16 Gauge
PART 230519
 Junior Adjustable Top Fixture
 Black Powder Coated
 1 22 88



• 13 gauge; Milford pin
 • 5¹/₁₆"H x 2¹/₁₆"W
 • 1/4" side flange
PART 263
 BB-100 Residential
 1 25 100



• Removable roller carrier
 • 13 gauge; Milford pin
 • 5¹/₄"H x 2³/₄"W
 • 1.30" side flange
PART 590
 SRBB-50 Residential
 1 25 100



• 13 gauge; Milford pin
 • 7¹/₈"H x 3¹/₈"W
 • 1/4" side flange
PART 259
 RBB-75 Residential
 1 20 60



• 13 gauge; Milford pin
 • 7¹/₈"H x 3¹/₈"W
 • 1/4" side flange
PART 230521
 RBB-75 Residential
 Black Powder Coated
 1 20 60

RES. & COMM. BOTTOM BRACKET

SOLD AS PAIRS



• For 2" and 3" track
 • 11 gauge; drilled pin
 • 11"H x 4⁵/₈"W
 • 1¹/₈" side and bottom flange
PART 3423
 BB-6 Commercial
 1 25 100



 **LOW HEADROOM**
 • 12 Gauge
PART 251
 Low Headroom Top Fixture
 1 15 65

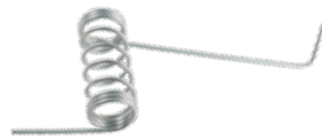

 **CABLE KEEPER**
 SOLD IN PAIRS
 • Prevents cable from jumping off drum
 • Installs over roller shaft on bottom fixture
 • Easy to fit on current and new installations
 • Works best with door bumpers
PART 412
 Cable Keeper
 1 25 100

LIKE THE BLACK POWDER COATED LOOK? THERE ARE MORE PRODUCTS!

We also have slide locks, top fixtures & bottom brackets in stock and ready to ship!

See page 26 for Hinges
 See page 37 for Slide Locks



SURE STOP BOTTOM BRACKET

SOLD IN PAIRS

- For use with 2" track
- Maximum door weight: 2,200 lbs.
- Minimum door weight: 66 lbs.
- Minimum cable tension required: 30 lbs.
- Additional cable length required: 5"
- Maximum cable diameter: 1/4"
- For use with hi-lift and vertical lift doors

PART 363

SBB-2 Stopping 2" Track

1 10

- For use with 3" track
- Maximum door weight: 2,200 lbs.
- Minimum door weight: 66 lbs.
- Minimum cable tension required: 15 lbs.
- Additional cable length required: 5 1/2"
- Maximum cable diameter: 1/4"
- For use with hi-lift and vertical lift doors

PART 364

SBB-3 Stopping 3" Track

1 10

- For use with 2" track
- Maximum door weight: 550 lbs.
- Minimum door weight: 97 lbs.
- Minimum cable tension required: 5 lbs.
- Additional cable length required: 9"
- Maximum cable diameter: 3/16"
- For use with standard, hi-lift and vertical lift doors

PART 404

SBB-2 Stopping Low Cable Tension 2" Track

1 10



OUTSIDE HOOKUP

FOR 2" AND 3" TRACK, 11 GAUGE, DRILLED PIN, SOLD AS PAIRS

- 6 1/2"H x 3 1/4"W

PART 258

BB-5 Outside Hookup - 2" Track

1 15 60

- 8 9/16"H x 4 5/8"W
- 1 5/8" side flange

PART 727

BB-7 Outside Hookup - 2" Track

1 10 25

- 10 15/16"H x 4 5/8"W
- 1 3/4" side flange

PART 728

BB-6 Outside Hookup - 3" Track

1 10 25



SAFETY

UPSELLING TO CUSTOMERS WHO KEEP EMPLOYEE SAFETY IN MIND

Creating a safe workplace for employees is always at the top of a business owner's list. It can be difficult to keep track of everything that's needed for the safest workplace. You can help your customer by selling them on the safety benefits of a Sure Stop Bottom Bracket.

In the event of a cable breakage or cable disengagement, the risk of a free-falling door is reduced. Investing a little more can bring peace of mind to employers wanting to create safer commercial installations.

SURE STOP BRACKETS & CABLE FITTINGS

29

All Pricing Subject To Change



END BEARING

SOLD AS SETS OR INDIVIDUALLY

• Sold individually, 8 gauge

PART 210
5 7/8" Flat End Bearing Plate
1 25 50

• Sold individually, 8 gauge

PART 211
6" Flat End Bearing Plate
1 25 50 100

• Sold as sets
• 3 3/8" shaft offset, 12 gauge

PART 209
3 3/8" Light Duty End Bearing Flange
1 25 50

• Sold as sets
• 4 3/8" shaft offset, 11 gauge

PART 215
4 3/8" Commercial End Bearing Plate
1 10 25



• Sold as sets
• 6" shaft offset, 8 gauge

PART 216
6" Commercial HD End Bearing Plate
1 10 25



• Sold as sets
• 6" shaft offset, 8 gauge, grease zerk fitting

PART 217
6" HD End Bearing Plate

PART 227
6" HD End Bearing Plate - 1 1/4" Bore
1 6



• Sold as sets
• For use with 1350-28 cable drums
• 7 1/2" shaft offset, 8 gauge
• Precision self-aligning bearing

PART 545
7 1/2" HD End Bearing Flange 1

PART 546
7 1/2" HD EBF - 1 1/4" Bore 1



CENTER BEARING

SOLD INDIVIDUALLY

• 3 3/8" shaft offset, 11 gauge

PART 225
3 3/8" Center Bearing Support
1 25 50



SPRING FAILURE DEVICE

SOLD INDIVIDUALLY

• For wall offsets 4 3/8", 5" and 6"
• For use with Right Hand Wound and Left Hand Wound models

PART 181462
Commercial Spring Failure Extension Bracket
1 25 50

• Compatible with 2" spring fittings
• One device per spring required
• 3 3/8" shaft offset
• For use with tube shaft
• Locking wheel includes (2) set screws and (1) self drilling screw
• Maximum door weight: 1 Spring - 150 lbs, 2 Springs - 470 lbs

PART 170204
Residential Device (left hand wound)

PART 170205
Residential Device (right hand wound)
1 10

• Compatible with 1 3/4", 2", 2 5/8", 3 3/4" and 6" fittings (*not for use with duplex springs*)
• One device per spring required
• 3 3/8" shaft offset (*optional extension bracket available*)
• For use with 1" keyed solid shaft (1 1/4" option available)
• Limit switch mounting location provided (*limit switch not included*)
• 1,850 lb-in max per device

PART 126474
Commercial Device (left-hand wound)

PART 126477
Commercial Device (right-hand wound)
1 10



• 4 3/8" shaft offset, 11 gauge

PART 226
4 3/8" Center Bearing Support
1 25 50

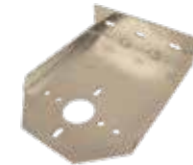

• For use with 1350-28 cable drums
• 7 1/2" shaft offset, 8 gauge

PART 533
7 1/2" Center Bearing Support 1

PART 534
7 1/2" Center Bearing Support 1 1/4" Bore 1



SPRING ANCHOR PLATES

SOLD INDIVIDUALLY

- For 1 $\frac{3}{4}$ " to 3 $\frac{3}{4}$ " ID springs
- 3 $\frac{3}{8}$ " shaft offset
- 12 gauge

PART 228
Notched Spring Anchor Plate
1 50 100

- For 1 $\frac{3}{4}$ " to 2 $\frac{5}{8}$ " ID springs
- 12 gauge

PART 229
Mini-Resi U.S.A.
1 50 100

- For 1 $\frac{3}{4}$ " to 6" ID springs
- 8 gauge

PART 230R
Universal Spring Anchor Right Hand
1 35 70

- For 1 $\frac{3}{4}$ " to 6" ID springs
- 8 gauge

PART 230L
Universal Spring Anchor Left Hand
1 35 70



- 6" shaft offset
- 8 gauge

PART 232
AP-3 600 Anchor Plate 1



- For 2 $\frac{1}{4}$ " ID springs

PART 5180097
Raynor Residential Anchor Plate
1 50 250



- For 3 $\frac{1}{2}$ " and 5 $\frac{1}{2}$ " ID springs

PART 5180572
Raynor Commercial Anchor Plate
1 50 250



STEEL BEARINGS & BUSHING

SOLD INDIVIDUALLY

- 2" O.D., for center support only

PART 234
1" Nylon Bushing
1 50 400

PART 507
1" Football Bearing
1 25 100

PART 723
1 $\frac{1}{4}$ " Football Bearing
1 25 100

- 2" O.D.
- Rating load at 35,000 12' door cycles

PART 235
1" Steel Bearing
1 25 250

- Rating: 400 lb.

PART 236
1 $\frac{1}{4}$ " Steel Bearing
1 25 200

- Rating: 900 lb.



FLANGE BEARING

SOLD INDIVIDUAL

- Includes grease zerk fitting
- Includes locking set screws

PART 338
1" UCF Precision Flange Bearing
1 6 64

- 2 $\frac{3}{4}$ " hole center distance

PART 339
1 $\frac{1}{4}$ " UCF Precision Flange Bearing
1 6 54

- 3 $\frac{1}{4}$ " hole center distance



PART 516
1" UCFL Precision Flange Bearing
1 6 40

- 3 $\frac{5}{16}$ " hole center distance
- Does not include locking set screws

PART 517
1 $\frac{1}{4}$ " UCFL Precision Flange Bearing
1 6 24

- 4 $\frac{3}{16}$ " hole center distance



CHAIN HOIST

SECTIONAL DOORS

- 54" of #41 roller chain
- Limit switch
- 12 set screws 5/16 - 18
- Wall mounting, 4:1 reduction

PART 172845

Disconnect Chain Hoist - 1" Bore
1 5 10

- 3' of #41 roller chain
- Wall mounting, 4:1 reduction

PART 560

2000 R Chain Hoist - 1" Shaft
1 5 10

PART 565

2000 R Chain Hoist - 1 1/4" Shaft
1 5 10

- 2 shaft collars
- Direct drive - 1" shaft
- Fits 3 3/8" minimum offset
- Requires keyed shaft

PART 716

Model 200 D Chain Hoist - 1" Shaft
1 5 10

- 2 shaft collars
- Direct drive - 1" shaft
- Requires 5 3/8" minimum offset
- Requires keyed shaft

PART 567

Model 2000 D Chain Hoist - 1" Shaft
1 5 10

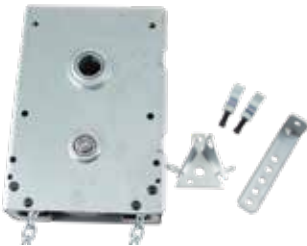

- 2 shaft collars
- 1 wall L-bracket
- Jack shaft mounting, 4.5:1 reduction
- Gear drive
- Fits 3 3/8" minimum offset
- Requires keyed shaft

PART 726

J.R.G. V2 Chain Hoist - 1" Shaft
1 5 10

PART 126690

J.R.G. V2 Chain Hoist - 1.25" Shaft
1 5 10



- 22" of #41 roller chain
- 2 shaft collars
- 1 wall L-bracket
- Jack shaft mounting, 4:1 reduction

PART 566

J.R. Chain Hoist - 1" Shaft
1 5 10

PART 126685

J.R. Chain Hoist - 1.25" Shaft
1 5 10



CHAIN TENSIONER

SECTIONAL OR ROLLING STEEL DOORS

- Controls hand chain movement
- Easy to install
- Floor or wall mount application

PART 557

Hand Chain Tensioner
1 5 10



CHAIN HOIST

ROLLING STEEL DOORS

- Fixed shaft chain hoist
- 4.4:1 ratio
- 26' hand chain

PART 126660

2000R-OM Wall Mount Chain Hoist
1 5 10

- 1:1 ratio
- Direct drive

PART 126632

RDD180 Stationary Chain Guide
1 5 10

- Single Reduction 3.2:1 with door's main shaft gear
- Head plate mounted
- 26' hand chain

PART 159011

RDRG Chain Hoist Basic Kit for Rolling Door
1 5 10

- Head plate mounted
- Includes 50B12 sprocket for 1" ID shaft
- 26' hand chain

PART 126635

RDR Chain Hoist Basic Kit
1 5 10



ROLLER CHAIN
SOLD INDIVIDUALLY

• 10' chain length - includes 1 master link

PART 1615
#40, 1/2" Pitch, 5/16"W
1 5 10



PART 1616
#41, 1/2" Pitch, 1/4"W
1 5 10



PART 1617
#48 aka #65, 1/2" Pitch, 1/8"W
1 5 10



PART 1618
#50, 5/8" Pitch, 3/8"W
1 5 10



MASTER
SOLD INDIVIDUALLY

PART 1610 #40 Master Link
1 25 100

PART 1611 #41 Master Link
1 25 100

PART 1612 #48 (#65) Master Link
1 25 100

PART 1613 #50 Master Link
1 25 100



OFFSET
SOLD INDIVIDUALLY

PART 1620 #40 1/2 Offset Link
1 25 100

PART 1621 #41 1/2 Offset Link
1 25 100

PART 1622 #48 (#65) 1/2 Offset Link
1 25 100

PART 1623 #50 1/2 Offset Link
1 25 100



CHAIN PARTS & ACCESSORIES



PART 562
Galvanized Hand Chain - 26'
1 5 10



- 36 tooth sprocket #41 chain (41B36)
- 1/4" keyway
- Includes 2 set screws

PART 563
Jack Shaft Sprocket - 1" Bore

PART 561
Jack Shaft Sprocket
1 1/4" Bore 1



PART 564
Chain Keeper
1 25 250



CHAIN TOOLS FOR REPAIRS



- Holder for ANSI chain sizes 35 - 60
- Allows easy replacement of broken links
- Holds chain together, leaving hands free
- Repair roller chain without removal

PART 420
Roller Chain Holder 1



- Removes link from pin on chain sizes 25 - 60
- Forged steel jaws
- Press out tip made of tool steel
- Replacement tip included
- American made

PART 422
Roller Chain Breaker 1



**ONE
PIECE
DOOR HINGE**

- Sold in pairs
- Springs and hardware not included
- Door Height: 6'10" to 7'4"
- Maximum Weight: 350 lbs
- Minimum Head Room: 1"
- Measure Down: 20"

PART ERJ7
One Piece Door Hinge Set
1 10 25

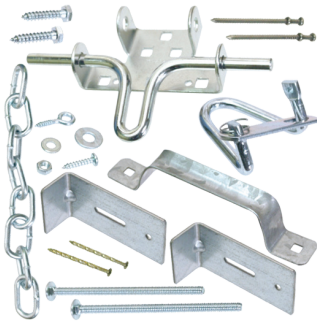

- Includes: W hooks, spring anchor chains, C hooks or W hooks, spring anchor plates, lock ferrule, door handle, slide lock, assortment of bolts, screws, and other assorted hardware

PART ERJ7HDWW
Hardware Bag, 2 Spring Wood Door
1 10 25

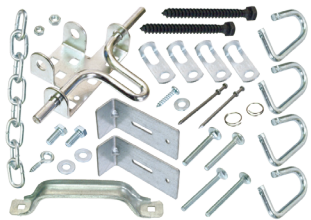

- Includes: C hooks, spring anchor chains, C hooks or W hooks, spring anchor plates, lock ferrule, door handle, slide lock, assortment of bolts, screws, and other assorted hardware

PART ERJ7HDWS
Hardware Bag, 2 Spring Steel Door
1 10 25



**SPRING
CLIP**

- For up to 1½" ID springs

PART 285
Small Extension Spring Clip
1 25



- For 1½"- 2½" ID springs

PART 287
Large Extension Spring Clip
1 25



- For 2½"- 4" ID springs

PART 288
Extra Large Extension Spring Clip
1 25



**DOOR
KNOCK**

- Height from face of door: 1½"
- Fasteners sold separately

PART 164895
Lion Head Knocker - Black
1 10 30



- Height from face of door: ¾"
- Fasteners sold separately

PART 172714
Fleur De Lis Knocker - Black
1 10 40



**CAST
IRON
HANDLE**

- Non-Operating
- Fasteners sold separately
- Height from door face: 2¼"

PART 174333
8" Fleur De Lis Handle Set - Black
1 5 20



SCREWS
BLACK PLATED
STAINLESS STEEL

- 250 Pieces per box
- Textured Finish

PART 1411
#8 x ½" Pan Head Sheet Metal Screw
1 5



- Phillips Head Screws
- 100 Pieces per box

PART 1410
#6 x 1" Oval Wood Screw
1 5



- 100 Pieces per box

PART 1412
#6 x ¾" Oval Sheet Metal Screw
1 5



- 100 Pieces per box
- Textured Finish

PART 1413
¼" x ½" Pan Head Sheet Metal Screw
1 5



- 100 Pieces per box

PART 1414
#8 x 1" Oval Sheet Metal Screw
1 5



STAMPED HINGE

SOLD IN PACKS OF 4

- .075" thick
- Crinkle finish
- Fasteners sold separately

PART 164202

16" Colonial Hinge - Black

1	5
10	25



PART 156871

16" Spear Hinge - Black

1	5
10	25

►Fasteners included



PART 167105

18" Spear Hinge - Black

1	3
6	25



PART 180196

24" Spear Hinge - Black

1	3
6	30



STUD

SOLD INDIVIDUALLY

- Height from face of door: 1/2"
- 3/4" Square, 3/4"L thread, 1 1/8"L overall

PART 172713

Door Studs - Black

1	20
100	400



CAST IRON HINGE

SOLD IN PACKS OF 2

- .25" thick
- Fasteners sold separately

PART 170926

16" Colonial Cast Iron Hinge - Black

1	5
10	20



PART 172712

16" Spear Cast Iron Hinge - Black

1	5
10	20



PART 172796

16" Fleur De Lis Cast Iron Hinge - Black

1	5
10	20



STAMPED PULL HANDLE

SOLD IN PACKS OF 2



- Height from door face: 1 5/8"
- Crinkle finish

PART 164203

9" Colonial Pull Handle - Black (left image)

1	10
25	100

►Fasteners sold separately

PART 180192

11 1/4" Spear Pull Handle - Black (right image)

1	10
25	100

►Fasteners included



CAST IRON PULL

SOLD INDIVIDUALLY

- Fasteners sold separately

PART 170924

9" Colonial Cast Iron Pull - Black (left image)

1	5
10	50

►Height from door face: 1 1/2"

PART 173970

10" Spear Cast Iron Pull - Black (center image)

1	5
10	25

►Height from door face: 1 5/8"

PART 169420

10" Fleur De Lis Cast Iron Pull - Black (right image)

1	5
10	50

►Height from door face: 1 3/4"



STAMPED LIFT HANDLE

SOLD INDIVIDUALLY



- Fasteners sold separately
- Crinkle finish

PART 172709

7" Colonial Lift Handle - Black

1	10
25	100

►Height from door face: 1 1/2"



PART 180195

8 3/4" Spear Lift Handle - Black

1	10
25	100

►Height from door face: 1 5/8"



CAST IRON LIFT HANDLE

SOLD INDIVIDUALLY



- Fasteners sold separately

PART 170922

6 1/4" Colonial Cast Iron Lift Handle - Black

1	5
10	25

►Height from door face: 1 1/2"



PART 173969

7 1/8" Spear Cast Iron Lift Handle - Black

1	5
10	25

►Height from door face: 1 3/8"



PART 172715

7 1/4" Fleur De Lis Cast Iron Lift Handle - Black

1	5
10	25

►Height from door face: 1 1/8"

mix&match

- Combine any CARRIAGE DOOR HARDWARE for best quantity pricing

CARRIAGE DOOR

35

All Pricing Subject To Change



MAGNETIC DOOR HARDWARE

EASY TO APPLY AND CHANGE. STAYS IN PLACE WITH NO DRILLING,
BLACK HAMMERED FINISH THAT WON'T RUST OR FADE

• Sold in packs of 4

PART HA106
18" Flexible Magnetic Hinge Set
1 25 50

PART HA110
¼" x 96" Flexible Magnetic
Dividing Line 1

PART 8002C
16" Magnetic Spade Hinge 1

PART 8008C
18" Magnetic Mission Hinge 1



• Sold in packs of 2
• Flush mount

PART HA108
8" Flexible Magnetic Handle Set
1 25 50



• 12 pieces per strip
PART HA130
Stick On Studs, 5/16"W
1 25 50



PART 8003C
1¾" Magnetic Clavos 1



PART 8005C
11" Magnetic Escutcheon
Plate Handle 1

123

• 100 pieces per box, 10 each of
numbers 0-9

PART HA104
5" Flexible Magnetic
Numbers 1



PART HA109
3½" Flexible Magnetic Keyhole
1 25 50



PART 8007C
4" Magnetic Ring Pull 1



PART 8001C
12" Magnetic Spade Handles 1

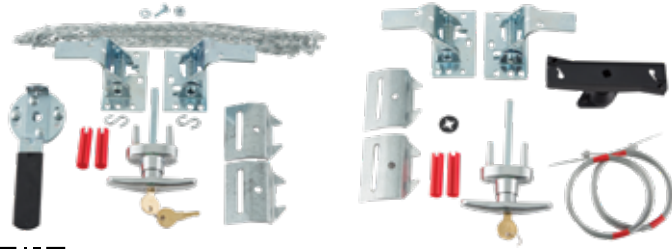

LATCH SET & PARTS

Includes: fasteners, spring latches and plates, 18 ft of sash chain, S-hooks, inside release handle, outside T-handle with 2 keys. Use Part #275A for keyed alike locks

PART 275
Spring Latch Set with Sash Chain
1 5 20

PART 275A
Spring Latch Set with Sash Chain
Keyed Alike
1 5 20

Includes: fasteners, spring latches and plates, (2) pieces of cable 9' 4", fiberglass reinforced nylon inside release handle, outside T-handle with 2 keys

PART 514
Spring Latch Set with Cable
1 20 200

- Keyslot for ease of cable installation & adjustment
- 8 lbs. force required to open

PART 573
Auto Latch
1 25 100



LOCK RIGHT HAND

- Includes hardware bag
- Works with Part #271

PART 274
Outside Lock Handle with keys
1 25 100



- Fits 1 3/8" through 2" thick doors
- 1 3/8" L posts, 3/4" L shaft
- 90° rotation
- Includes: push nut and (2) keys
- Requires (2) 10-24 fasteners which are not included

PART 126098
Keyed T Handle
1 25 100



DEAD BOLT LOCK & PARTS

- Zinc die cast
- Includes: dead bolt, 5 pin tumbler cylinder, fasteners and 2 keys (Schlage key pattern)

PART 518
Die Cast Dead Bolt Lock Set
1 15 60



- Includes: inside and outside mounting handles, mounting hardware and fasteners
- Chrome plated exterior components
- Fits up to 2" thick doors
- Zinc plated 3/4" shaft

PART 137460
Dummy T Handle Set
1 15 60



- Includes: 5 pin tumbler cylinder, fasteners and 2 keys (Schlage key pattern)
- Fits up to 4" thick doors

PART 132928
Replacement Cylinder
1 30 60



SLIDE LOCK

- Fits 2" track only
- Case width: 2 1/4"

PART 503
Residential 2" Slide Lock
1 25 100



PART 230520
Universal Slide Lock for 2" and 3"
Track - Black Powder Coated
1 25 70

PART 270
Universal Slide Lock for 2" and 3"
Track - Uncoated
1 25 70



- Right hand
- 7 1/2" bar with 2 1/8" throw
- Works with #274

PART 271
End Style Lock for 2" and 3" track
1 25 50



KEYED OUTSIDE DISCONNECT FOR OUTSIDE OF DOOR

- Includes: mounting hardware, 3' of cable and 2 keys
- Keyed randomly or use part #272A for keyed alike locks

PART 272
Keyed Outside Disconnect
1 10
25 300

PART 272A
Keyed Alike
1 10
25 300

LOCK PARTS

Don't see some parts you're looking for? Additional lock parts are on the next page!

LOCKS



LOCK PARTS

- Gussets at all bends for strength
- Plastic covered handle

PART 126011
Inside Release Handle - Zinc
1 25 100



- 1½" slots for adjustment
- 7/16" engagement tabs for more security

PART 574
Auto Latch Striker
1 25 100



- #8 sold in 5' lengths
- For locks and fire door use

PART 143167
Sash Chain, #8 - 5'L
1 10 25



PART 424
¼" x 2½" S-Hook
1 100



- For use with sash chain and other uses

PART 137814
1¼" L x 5/8" W S-Hook, #8
1 25 100



ARB ADJUSTABLE

ADJUSTABLE FOR 18" - 24" SECTIONS

- (4) 5/16"-18 bolts, clevis pin and cotter ring included

PART 233
ARB - Half Hinge - Zinc
1 10 50

PART 252
ARB - Full Hinge - Zinc
1 10 50

PART 519
ARB - Zinc
1 25 50

PART 525
ARB - White
1 25 50

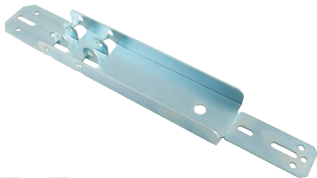

ORB

- 12 gauge steel
- Clevis pin and cotter ring included

PART 497
18" ORB - Zinc
1 20 40

PART 498
21" ORB - Zinc
1 20 40

PART 504
21" ORB - White
1 20 40

PART 499
24" ORB - Zinc
1 20 40

ORB NARROW

- Fits 21" sections, field trim to fit 18" sections
- Clevis pin and cotter ring included

PART 508
Narrow ORB - White
1 25 50

PART 509
Narrow ORB - Zinc
1 25 50



EXHAUST PORT



¼" OR 2" THICK

- Includes fasteners

¼" THICK

- Use on non-insulated door panels

PART 580
3" Exhaust Port
1 5 20

PART 581
4" Exhaust Port
1 5 20

PART 724
5" Exhaust Port
1 5 20

2" THICK

- Use on insulated door panels

PART 584
3" Exhaust Port
1 5 20

PART 585
4" Exhaust Port
1 5 20

PART 725
5" Exhaust Port
1 5 20



T-RAIL MOUNTING BRACKET

EASY FOR HEADER, RAFTER, OR CEILING MOUNTING

- Multiple attachment points for T-Rail mounting
- For use with LiftMaster, Chamberlain and Craftsman T-Rail operators
- 12"H x 2¾"W channel x 1½"D, mounting hardware and fasteners not included

PART 527
T-Rail Mounting Bracket - Galvanized
1 10 50

PART 528
T-Rail Mounting Bracket - White
1 10 50



DOOR BUMPER

SOLD IN PAIRS

- Zinc plated steel with a 2" diameter rubber bumper
- 12 gauge bracket for 3/8" bolts
- Approximate compression: 10 lb/in.

PART 417

Push Down Bumper Spring - 15" with 6" Travel

1 5 20

PART 419

Push-Down Bumper Spring - 27" with 15" Travel

1 5 15

- 50 dB noise rating for quieter working environment
- Zinc plated steel with a 2" diameter rubber bumper
- 12 gauge bracket for 3/8" bolts
- Approximate compression: 10 lb/in

PART 419S

Quiet Push-Down Bumper Spring - 27" with 15" Travel

1 5 15

- Includes restraint strap
- Overall Length: 12 1/2"
- Painted black
- Supplied with mounting bracket & hardware

PART 416B

Leaf Bumper Spring

1 8 48



QUICK CLOSE FIXTURE

SOLD IN PAIRS

- Reduces headroom requirement by 1 1/2" to 2 1/2"
- Solves low headroom problems when installing garage door openers
- Serves same purpose as double track hardware
- Used at initial installation or easily added when needed

PART 256

Quick Close Fixture

1 20 50



EZ KIT

LOW HEADROOM SOLD IN PAIRS

- 3 -piece kit
- Operate in as low as 8" of headroom
- Works on manual doors

PART 223179

EZ Low Headroom Kit

1 6 12



SUPER SNEAKY LOW HEADROOM

SOLD IN PAIRS

- Requires garage door operator
- Install a standard lift door with 6" minimum headroom
- Eliminates the need for double low headroom track
- Works with standard 12" or 15" radius track
- Easy installation, detailed instructions included

PART SNEAKYLHTB

Super Sneaky Low Headroom Top Brackets

1 10 25

PART SNEAKYOEB

SS Operator Extension Bracket

1 10 25

- Eliminates the headroom required to mount an operator
- Virtually eliminates "door rub"
- Resolves "door opening hang" issues



O&E LH BRACKET

LOW HEADROOM BRACKET, SOLD IN PAIRS

- Used on torsion or extension spring doors up to 8'H
- Operate extension spring doors in a minimum of 7" of headroom

PART 257

O&E Low Headroom Bracket

1 8 16

SPACE SAVERS

FOR SPACES WITH LITTLE HEADROOM

Sometimes the standard 17" of clearance is not always achievable. Whether the ceiling is too low, or a cross beam is in an undesirable place, these low-headroom bracket options provide a cost effective solution.

SUPER SNEAKY BRACKETS are designed for easy installation requiring only 6" of headroom for normal door operation.

EZ LOW HEADROOM KITS pair with standard track, providing a hinge system that attaches directly to your door.



LEARN MORE

Scan this code to learn about **LOW HEADROOM OPTIONS** by watching this video!

DOOR BUMPERS & LOW HEADROOM



TYPE AB

7/16" SHEET METAL SCREW INDENTED HEX
WASHER HEAD Max RPM = 900

PART 743	1/4" x 3/4"-1,000 pcs	1	5
PART 743-250	1/4" x 3/4"-250 pcs	1	5



SELF DRILL & TAP TEK

SCREW INDENTED HEX WASHER HEAD

1/4" HEAD Max RPM = 2000

PART 3026BX	8-18 x 3/4" (#2 PT)-1,000 pcs	1	5
PART 3026BX-250	8-18 x 3/4" (#2 PT)-250 pcs	1	5

7/16" HEAD Max RPM = 2000

PART 749	1/4"-20 x 5/8" (#2 PT)-1,000 pcs	1	5
PART 749-250	1/4"-20 x 5/8" (#2 PT)-250 pcs	1	5
PART 750	1/4"-20 x 3/4" (#2 PT)-1,000 pcs	1	5
PART 750-250	1/4"-20 x 3/4" (#2 PT)-250 pcs	1	5
PART 751	1/4"-20 x 1" (#2 PT)-1,000 pcs	1	5
PART 751-250	1/4"-20 x 1" (#2 PT)-250 pcs	1	5
PART 752	1/4"-20 x 1" (#3 PT)-2,500 pcs	1	5
PART 753	1/4"-20 x 1" (#3 PT)-1,000 pcs	1	5
PART 753-250	1/4"-20 x 1" (#3 PT)-250 pcs	1	5
PART 754	5/16"-12 x 1" (#4 PT)-1,000 pcs	1	5
PART 754-250	5/16"-12 x 1" (#4 PT)-250 pcs	1	5

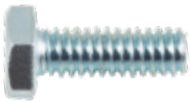

HEX HEAD BOLT

FULL THREAD

1/4" BOLT WITH 7/16" HEAD Max torque = 6

PART 775	1/4"-20 x 3/4"-1,000 pcs	1	5
PART 775-250	1/4"-20 x 3/4"-250 pcs	1	5
PART 776	1/4"-20 x 1"-1,000 pcs	1	5
PART 776-250	1/4"-20 x 1"-250 pcs	1	5

5/16" BOLT WITH 1/2" HEAD Max torque = 12

PART 774	5/16"-18 x 3/4"-1,000 pcs	1	5
PART 774-250	5/16"-18 x 3/4"-250 pcs	1	5
PART 778	5/16"-18 x 1"-1,000 pcs	1	5
PART 778-250	5/16"-18 x 1"-250 pcs	1	5

3/8" BOLT WITH 9/16" HEAD Max torque = 22

PART 781	3/8"-16 x 3/4"-1,000 pcs	1	5
PART 781-250	3/8"-16 x 3/4"-250 pcs	1	5
PART 780	3/8"-16 x 1 1/2"-1,000 pcs	1	5
PART 780-250	3/8"-16 x 1 1/2"-250 pcs	1	5
PART 783	3/8"-16 x 1 3/4"-1,000 pcs	1	5
PART 783-250	3/8"-16 x 1 3/4"-250 pcs	1	5



LAG SCREW

7/16" HEX WASHER

REGULAR PROFILE

PART 757	5/16" x 1 5/8"-1,000 pcs	1	5
PART 757-250	5/16" x 1 5/8"-250 pcs	1	5
PART 758	5/16" x 1 3/4"-1,000 pcs	1	5
PART 758-250	5/16" x 1 3/4"-250 pcs	1	5
PART 760	5/16" x 2"-1,000 pcs	1	5
PART 760-250	5/16" x 2"-250 pcs	1	5
PART 762	5/16" x 2 1/2"-1,000 pcs	1	5
PART 762-250	5/16" x 2 1/2"-250 pcs	1	5
PART 768	5/16" x 3"-500 pcs	1	5
PART 768-250	5/16" x 3"-250 pcs	1	5
PART 767	1/4" x 1"-1,000 pcs	1	5
PART 767-250	1/4" x 1"-250 pcs	1	5



HIGH PROFILE

PART 769	5/16" x 1 5/8"-1,000 pcs	1	5
PART 769-250	5/16" x 1 5/8"-250 pcs	1	5
PART 771	5/16" x 1 3/4"-1,000 pcs	1	5
PART 771-250	5/16" x 1 3/4"-250 pcs	1	5
PART 772	5/16" x 2"-1,000 pcs	1	5
PART 772-250	5/16" x 2"-250 pcs	1	5
PART 773	5/16" x 2 1/2"-1,000 pcs	1	5
PART 773-250	5/16" x 2 1/2"-250 pcs	1	5
PART 759	5/16" x 3"-500 pcs	1	5
PART 759-250	5/16" x 3"-250 pcs	1	5



COTTER PIN

PART 798	3/32" x 1"-100 pcs	1	5
-----------------	--------------------	---	---



CLEVIS PIN

PART 797	5/16" x 1"-100 pcs	1	5
-----------------	--------------------	---	---



FLAT WASHER

PART 733	5/16" Inside Opening-1,000 pcs	1	5
PART 733-250	5/16" Inside Opening-250 pcs	1	5
PART 735	3/8" Inside Opening-1,000 pcs	1	5
PART 735-250	3/8" Inside Opening-250 pcs	1	5



ROUND

CARRIAGE BOLT Full Length Thread Max torque = 12

PART 736	5/16"-18 x 3/4"-1,000 pcs	1	5
PART 736-250	5/16"-18 x 3/4"-250 pcs	1	5
PART 739	3/8"-16 x 1"-1,000 pcs	1	5
PART 739-250	3/8"-16 x 1"-250 pcs	1	5



FLAT

CARRIAGE BOLT Full Length Thread Max torque = 6

PART 761	1/4"-20 x 1 7/8"-1,000 pcs	1	5
PART 761-250	1/4"-20 x 1 7/8"-250 pcs	1	5
PART 763	1/4"-20 x 2 1/4"-1,000 pcs	1	5
PART 763-250	1/4"-20 x 2 1/4"-250 pcs	1	5
PART 766	1/4"-20 x 2 1/2"-1,000 pcs	1	5
PART 766-250	1/4"-20 x 2 1/2"-250 pcs	1	5



TRACK BOLT

SLOTTED Knurled Shank Max torque = 6

PART 756	1/4"-20 x 5/8"-1,000 pcs	1	5
PART 756-250	1/4"-20 x 5/8"-250 pcs	1	5
PART 747	1/4"-20 x 1"-1,000 pcs	1	5
PART 747-250	1/4"-20 x 1"-250 pcs	1	5



SLEEVE ANCHOR

SECURE INTO CONCRETE BRICK OR BLOCK

PART 801	5/16" x 1 1/2"-100 pcs	1	5
PART 802	3/8" x 1 7/8"-100 pcs	1	5
PART 803	3/8" x 3"-50 pcs	1	5
PART 804	3/8" x 4"-50 pcs	1	5



SET SCREW

SQUARE HEAD, SOLD INDIVIDUALLY

• Not eligible for Mix and Match pricing

PART 370A	3/8" x 1"	1	100
PART 371A	3/8" x 1 1/4"	1	100
PART 372A	3/8" x 1 1/2"	1	100



HEX NUT

PART 786	1/4"-20-1,000 pcs	1	5
PART 786-250	1/4"-20-250 pcs	1	5
PART 788	5/16"-18-1,000 pcs	1	5
PART 788-250	5/16"-18-250 pcs	1	5
PART 790	3/8"-16-1,000 pcs	1	5
PART 790-250	3/8"-16-250 pcs	1	5



FLANGE NUT

SERRATED FLANGE FACE TO PROVIDE LOCKING

PART 784	1/4"-20-1,000 pcs	1	5
PART 784-250	1/4"-20-250 pcs	1	5
PART 764	5/16"-18-1,000 pcs	1	5
PART 764-250	5/16"-18-250 pcs	1	5
PART 765	3/8"-16-1,000 pcs	1	5
PART 765-250	3/8"-16-250 pcs	1	5



KEPS NUT

LOCK WASHER & NUT

PART 796	1/4"-20-1,000 pcs	1	5
PART 796-250	1/4"-20-250 pcs	1	5
PART 794	5/16"-18-1,000 pcs	1	5
PART 794-250	5/16"-18-250 pcs	1	5



TAPCON SCREW

CONCRETE HEX HEAD

PART CS125	1/4" x 1 1/4"-100 pcs	1	5
PART CS175	1/4" x 1 3/4"-100 pcs	1	5
PART CS225	1/4" x 2 1/4"-100 pcs	1	5
PART CS275	1/4" x 2 3/4"-100 pcs	1	5
PART CS325	1/4" x 3 1/4"-100 pcs	1	5

mix&match

• Combine any SCREWS, BOLTS, NUTS AND WASHERS for best quantity pricing

FASTENERS



FLAG BRACKET



SOLD IN PAIRS

• For doors 1" to 2" thick

PART 447

Universal Slotted Flag Bracket

1 10 50



JUNCTION PLATE



• Joins double low headroom track

PART 515

Track Junction Plate

1 25 100



PULL ROPE



PART 283

¼" Nylon Pull Rope - 500 ft

1 5



STRUT CLIP



PART 819

Strut Clip

1 100 2000



SPLICE PLATE



PART 466

Splice Plate (7' to 10'H door)

1 25 100

PART 467

Splice Plate (9' to 12'H door)

1 25 100

PART 468

Splice Plate (11' to 14'H door)

1 25 100



STEP PLATE



PART 276

4½" x 1½" Wide Step Plate

1 25 125

PART 277

3" x 1¼" Narrow Step Plate

1 25 125



TORSION HARDWARE BOXES



Includes: manual, caution and warning stickers, jamb brackets, 2" 11-ball nylon rollers, drums, nylon bushing, end bearing plates, 14 gauge hinges, cable, rope, top fixtures, bottom brackets, lift handles, flag brackets, spring anchor plate, assortment of bolts, screws, and other assorted hardware

PART RESBX7S

Residential Hardware Box 7'H
Single Wide Door

1 15 30

PART RESBX7D

Residential Hardware Box 7'H
Double Wide Door

1 15 30

PART

Residential Hardware Box 8'H
Single Wide Door

1 15 30

PART RESBX8D

Residential Hardware Box 8'H
Double Wide Door

1 15 30



FIRE DOOR ACCESSORIES



• #8 sold in 5' lengths
• For locks and fire door use

PART 143167

Sash Chain, #8 - 5'L

1 10 25



• 165 degree separation
• Holds up to 30 pounds pull
• 2½"L x 7/8"W x 1/8"D

PART A165

165° Fusible Link 1 - 30lb Load

1 25 50



• For use with sash chain and other uses

PART 137814

1³⁄₁₆"L x 5/8"W S-Hook, #8

1 25 100



• 165 degree separation
• Holds up to 10 pounds pull
• 1½"L x 9/16"W x 1/8"D

PART B165

165° Fusible Link 1 - 10lb Load

1 25 50



EXTENSION HARDWARE BOXES



Includes: manual, caution & warning stickers, jamb brackets, 2" 11-ball nylon rollers, 3" pulley & forks, 14 ga hinges, bottom brackets, lift handle, top fixtures, cables, rope, flag brackets, assortment of bolts & screws.

PART EXTBX7S

Residential Hardware Box 7'H
Single Wide Door - Extension

1 15 30

PART EXTBX7D

Residential Hardware Box 7'H
Double Wide Door - Extension

1 15 30

PART

Residential Hardware Box 8'H
Single Wide Door - Extension

1 15 30

PART EXTBX8D

Residential Hardware Box 8'H
Double Wide Door - Extension

1 15 30

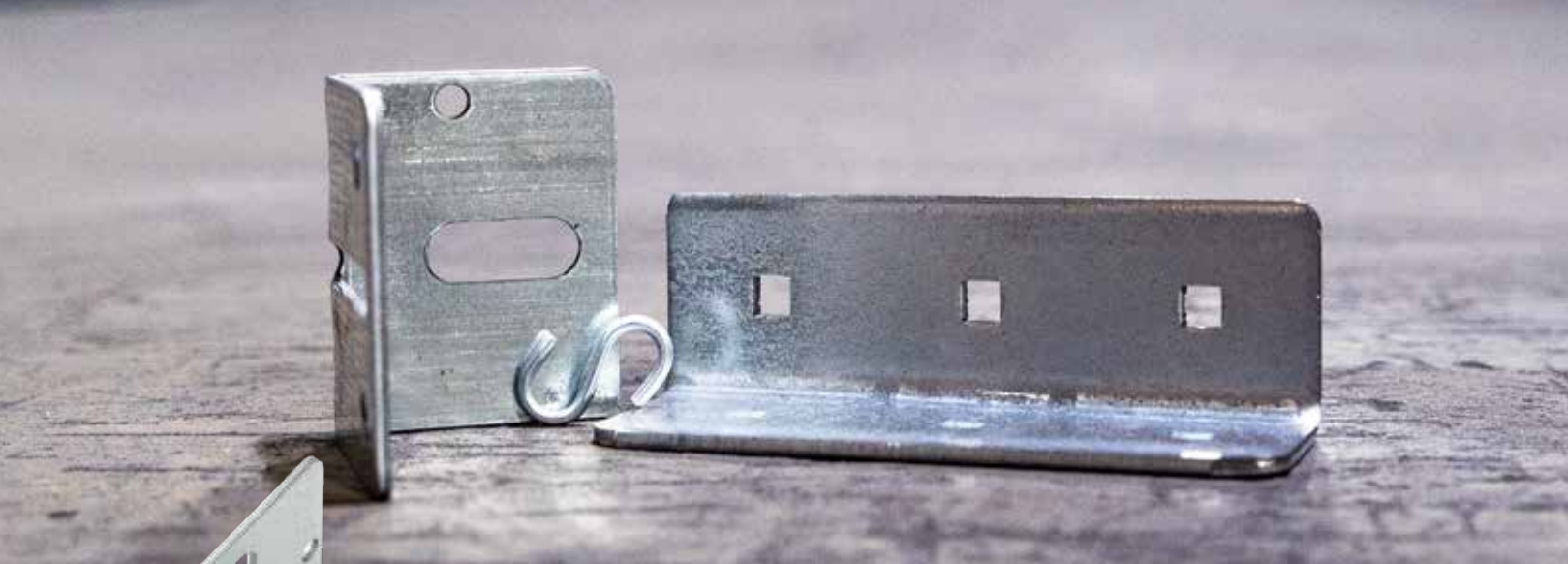

**SCAN TO SEE THE
DIGITAL COPY OF
OUR SIZE CHART**
or see page 165 in the
back of the catalog



JAMB BRACKET

SOLD INDIVIDUALLY

PART 1001	J-1 Jamb Bracket	PART 1009	J-9 Jamb Bracket
1	50 100	1	50 100
PART 1003	J-3 Jamb Bracket	PART 1010	J-10 Jamb Bracket
1	50 100	1	50 100
PART 1004	J-4 Jamb Bracket	PART 1011	J-11 Jamb Bracket
1	50 100	1	50 100
PART 1005	J-5 Jamb Bracket	PART 1012	J-12 Jamb Bracket
1	50 100	1	50 100
PART 1006	J-6 Jamb Bracket	PART 1013	J-13 Jamb Bracket
1	50 100	1	50 100
PART 1007	J-7 Jamb Bracket	PART 1014	J-14 Jamb Bracket
1	50 100	1	50 100
PART 1008	J-8 Jamb Bracket		
1	50 100		



ADJUSTABLE SPREADER ARM

INCLUDES 2 SHAFT COLLARS

PART 204C	Adjustable Spreader Arm - 1" Shaft	1	15	30	90
PART 151411	Adjustable Spreader Arm - 1¼" Shaft	1	15	30	90



VERTICAL ANGLE

FOR USE WITH SPLICE PLATES

PART 462	19" Vertical Angle
1	40 250



SECTION SAVER

FOR MANUAL HIGH
AND VERTICAL LIFT
SECTIONAL DOORS

- Stops "door drift" into opening
- Includes all mounting hardware
- Eliminates damage to sectional doors

PART 822	Section Saver Door Ratchet
1	6



LIFT HANDLE

CLOSED GRIP

PART 273	Lift Handle
1	100 200



1 1/4" X 1 1/4" GALVANIZED

PART 125125818 8' 18 Gauge	1	50	200
PART 453 8' 16 Gauge	1	50	200
PART 62518 8' 14 Gauge	1	50	200
PART 62520 10' 14 Gauge	1	50	200
PART 452 8' 13 Gauge	1	50	200
PART 450 10' 13 Gauge	1	50	200
PART 62530 10' 12 Gauge	1	50	200

• Sold in quantities of 250

PART 62510DS 10' 16 Gauge	1	600	1000
----------------------------------	---	-----	------

• Sold in quantities of 100

PART 62528DS 8' 12 Gauge	1	300	600
---------------------------------	---	-----	-----

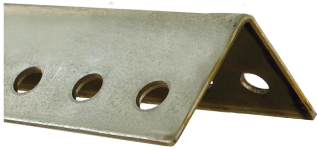
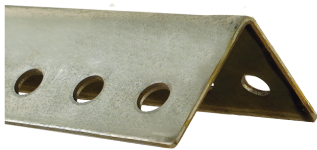

1 1/2" X 1 1/2" GALVANIZED

PART 15151012 10' 12 Gauge	1	50	200
	400	600	

PART 1515812 8' 12 Gauge	1	50	200
	400	600	



2" X 2" GALVANIZED

PART 461 10' 12 Gauge	1	200	600
------------------------------	---	-----	-----

• Sold in quantities of 100

PART 62538DS 8' 12 Gauge	1	300	600
---------------------------------	---	-----	-----

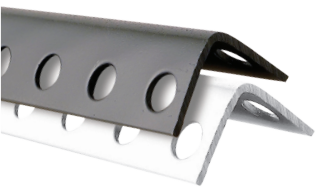

1 1/4" X 1 1/4" POWDER COATED



• Grey Powder Coating

PART 12512512GP 8'3" 12 Ga.	1	80	320
------------------------------------	---	----	-----

• White Powder Coating

PART 12512512WP 8'3" 12 Ga.	1	80	320
------------------------------------	---	----	-----



1 5/8" X 2 3/8" GALVANIZED

PART 451 10' 12 Gauge	1	50	200
	400	600	

POPULAR ANGLE IS IN-STOCK

Almost all of the angle we carry is in-stock & ready to ship! If we don't have it in-stock, don't worry, we've got you covered. We'll have product shipped to you directly from manufacturers all across the country.

TIPS TO SAVE ON SHIPPING!

Angle that is not in-stock is direct shipped from multiple warehouses located throughout the US to reduce transit times and freight costs.

Combine perforated angle and struts orders into a single shipment to reduce costs.



2" HORIZONTAL PUNCHED TRACK

15 PAIRS PER PALLET

• 14 gauge 22" angle

PART HTRACK7S12

2" .062 Gauge 8' 6"L with 12" Radius

1	2
4	8

PART HTRACK8S12

2" .062 Gauge 9' 6"L with 12" Radius

1	2
4	8

• 14 gauge 82" angle

PART HTRACK7D12

2" .062 Gauge 8' 6"L with 12" Radius

1	2
4	8

PART HTRACK8D12

2" .062 Gauge 9' 6"L with 12" Radius

1	2
4	8

• 14 gauge 82" angle

PART HTRACK7D15

2" .062 Gauge 8' 6"L with 15" Radius

1	2
4	8

PART HTRACK8D15

2" .062 Gauge 9' 6"L with 15" Radius

1	2
4	8



2" LOW HEADROOM HORIZONTAL TRACK

15 PAIRS PER PALLET

• 3 1/2" low headroom 14 gauge 82" angle

PART HTRACK7LH

2" Horizontal Low Headroom Punched .062 Gauge 8' 6"L with 15" Radius

1	2	4	8
---	---	---	---

PART HTRACK7LH12

2" Horizontal Low Headroom Punched .062 Gauge 8' 6"L with 12" Radius

1	2	4	8
---	---	---	---



2" VERTICAL & RAW TRACK

15 PAIRS PER PALLET

PART VTRACK7

2" Vertical Track Punched .051 Gauge 76"L

1	2	4	8
---	---	---	---

PART VTRACK8

2" Vertical Track Punched .051 Gauge 88"L

1	2	4	8
---	---	---	---

FOR DOOR UP TO 14'H

PART R2TRACK14

2" Raw Track .075 Gauge x 13'-4"L

1	2	4	8
---	---	---	---

PART R3TRACK14

3" Raw Track .100 Gauge x 13'-4"L

1	2	4	8
---	---	---	---



SHAFT KEY



1/4" x 1/4" x 3"

• 3" usable surface with 30° bend 3/4"L

PART 340

Bent Shaft Key

1	50	500
---	----	-----



• Not recommended for cable drums

PART 341

Straight Shaft Key

1	50	500
---	----	-----



SHAFT COLLAR

PART 205

1" Shaft Collar with Set Screw

1	10	25	200
---	----	----	-----

PART 206

1 1/4" Shaft Collar with Set Screw

1	10	25	200
---	----	----	-----

PART 505

1" Split Shaft Collar (right image)

1	10	25	200
---	----	----	-----

PART 506

1 1/4" Split Shaft Collar (right image)

1	10	25	200
---	----	----	-----



SHAFT COUPLER

• 1/4" Keyway
• Malleable Iron

PART 280

1" Shaft Coupler - Adjustable

1	10
---	----

PART 281

1 1/4" Shaft Coupler - Adjustable

1	10
---	----



• 1/4" Keyway, 4 3/4"L

PART 720

1" Shaft Coupler - Not Adjustable

1	5	20
---	---	----

PART 721

1 1/4" Shaft Coupler - Not Adjustable

1	5	20
---	---	----

TRACK, SHAFT KEYS, SHAFT COLLAR & COUPLER



1" TUBE SHAFT



GALVANIZED

- 16 gauge - 8', 9', 10', 12' and 14' lengths
- 14 gauge - 16' and 18' lengths
- Full Bundle 100 pieces

PART GT8

1" x 8'-10" Tube, 16 Gauge
1 10 100

PART GT9

1" x 9'-10" Tube, 16 Gauge
1 10 100

PART

1" x 10'-10" Tube, 16 Gauge
1 10 100

PART GT12

1" x 12'-10" Tube, 16 Gauge
1 10 100

PART GT14

1" x 14'-10" Tube, 16 Gauge
1 10 100

PART GT16

1" x 16'-10" Tube, 14 Gauge
1 10 100

PART GT18

1" x 18'-10" Tube, 14 Gauge
1 10 100



1" SOLID SHAFT



KEYED FULL, ZINC PLATED

- Full Bundle 50 pieces

PART 334

1" x 6'-6" Solid Shaft
1 10 50

PART 358

1" x 7'-6" Solid Shaft
1 10 50

PART 359

1" x 8'-6" Solid Shaft
1 10 50

PART 379

1" x 9' 6" Solid Shaft
1 10 50

PART 382

1" x 10'-6" Solid Shaft
1 10 50

PART 384

1" x 11'-6" Solid Shaft
1 10 50

PART 387

1" x 12'-6" Solid Shaft
1 10 50

PART 388

1" x 13'-6" Solid Shaft
1 10 50

PART 342

1" x 19' Solid Shaft
1 10 50

1 1/4" SOLID SHAFT



PART 399

1 1/4" x 13'-6" Solid Shaft
1 10
50 100

PART 389

1 1/4" x 19' Solid Shaft
1 10
50 100



2 1/4" STRUT

GALVANIZED

- Hemmed edges
- 60 per Bundle

IN-STOCK

PART 62921	8' 22 Gauge Strut	1	5
PART 62922	9' 22 Gauge Strut	1	5
PART 62923	10' 22 Gauge Strut	1	5
PART 62924	12' 22 Gauge Strut	1	5
PART 62925	14' 22 Gauge Strut	1	5
PART 62927	16' 22 Gauge Strut	1	5
PART 62929	18' 22 Gauge Strut	1	5

DIRECT SHIP

- 22 Gauge

PART 62921DS	8' 22 Gauge Strut	1	5
PART 62922DS	9' 22 Gauge Strut	1	5
PART 62923DS	10' 22 Gauge Strut	1	5
PART 62924DS	12' 22 Gauge Strut	1	5
PART 62925DS	14' 22 Gauge Strut	1	5
PART 62927DS	16' 22 Gauge Strut	1	5
PART 62929DS	18' 22 Gauge Strut	1	5



3" STRUT

40 PER BUNDLE

DIRECT SHIP

- 20 Gauge

PART 62932N	9' 20 Gauge Strut	1	5
PART 62935N	16' 20 Gauge Strut	1	5
PART 62936N	18' 20 Gauge Strut	1	5
PART 62937N	20' 20 Gauge Strut	1	5
PART 62939N	24' 20 Gauge Strut	1	5



RESIDENTIAL OPERATORS

**RAISING
STANDARDS
TO PROTECT
WHAT MATTERS
THE MOST**

LiftMaster®

servicespring.com | 833.SSC.DOOR



87504-267

12V DC BATTERY BACK UP BELT DRIVE OPERATOR WITH INTEGRATED CAMERA (7', 8', & 10')

- Elite series 12V DC motor with battery back up
- Security+2.0 MyQ®
- Posilock protection
- 2000 lumen 360° LED corner to corner lighting system
- Integrated camera with 2-way communication
- (2) 893MAX 3 button remote controls
- 878MAX wireless, keyless entry 880LMW smart control panel
- 878MAX wireless keypad
- 485LM standby battery
- Lifetime motor warranty – 5 year parts
- California SB-969 compliant



84505R

12V DC LED BELT DRIVE OPERATOR WITH INTEGRATED CAMERA (7', 8' & 10')



- Premium Series 12V DC motor
- Security+2.0 MyQ®
- Posilock protection
- 1500 Lumen LED dual light lens
- Integrated camera with 2-way communication
- 893LM 3 button remote control
- 882LMW multi-function control panel
- Lifetime motor warranty – 1 year parts



87802

12V DC BATTERY BACK UP CHAIN DRIVE OPERATOR (7', 8' & 10')

- Elite Series 12V DC motor with battery back up
- I-beam rail system
- Security+2.0 MyQ®
- Automatic garage door lock capable (sold separately)
- 2000 lumen 360° LED corner to corner lighting system
- 893MAX 3 button remote control
- 880LMW Smart control panel
- 878MAX wireless keypad
- 485LM standby battery
- Lifetime motor warranty – 5 year parts
- California SB-969 compliant



84602

12V DC BATTERY BACK UP CHAIN DRIVE OPERATOR

- Available rail lengths: 7', 8', 10'
- Premium series 12v DC motor with Battery back up
- Security+2.0 MyQ®
- Posilock protection
- 1500 lumen LED dual light lens
- 893LM 3 button remote control
- 886LMW motion detecting control panel
- 485LM standby battery
- Lifetime motor warranty – 1 year parts
- California SB-969 compliant



BATTERY BACK UP:

See page 56 for LiftMaster's Integrated Battery Backup System. For use with LiftMaster models 8500W, 87504-267, 87802 & 84602 operators.



• Combine any LIFTMASTER RESIDENTIAL OPERATORS for best quantity pricing



KEY BY AMAZON

SSC DISTRIBUTOR ID: 11215

Using the SSC Distributor ID, register your LiftMaster Partner Rewards account to track myQ and Key by Amazon connections. Scan the codes below to see how to connect to Key and see the User Guide to submit rewards claims.



START YOUR ACCOUNT WITH LIFTMASTER REWARDS!

ENTER DISTRIBUTOR ID: 11215



CONNECTING INSTRUCTIONS



CLAIMS GUIDE



CAMERA

The LiftMaster Smart Garage Camera™ is compatible with all MyQ® connected garage door openers. It works directly with all LiftMaster openers with the Wi-Fi logo and can work with most garage door opener brands manufactured after 1993 when paired with the MyQ® Smart Garage™ Hub (821LMB).

- MyQ® Connected: monitor the garage through a live feed or recorded event using the MyQ® app.
- Video camera begins recording when motion is detected.
- Easy setup with Bluetooth and magnetic mounting base.
- Enables secure in-garage delivery for Amazon Prime packages.

PART MYQSGC1WLM

LiftMaster Smart Garage Camera 1



DEADBOLT

- Key free – no key hole means no lock picking or keys to lose
- 9V battery back-up
- Works with Key by Amazon to provide a seamless delivery experience

PART LMDBPACKOB

LiftMaster Yale Smart Touchscreen Deadbolt Lock - Oil Rubbed Bronze 1

PART LMDBPACKSN

LiftMaster Yale Smart Touchscreen Deadbolt Lock - Satin Nickel 1



LEVER LOCK

- Key free – no key hole means no lock picking or keys to lose
- 9V battery back-up
- Works with Key by Amazon to provide a seamless delivery experience

PART LMLEVPACKOB

LiftMaster Yale Smart Keypad Lever Lock Oil Rubbed Bronze 1

PART LMLEVPACKSN

LiftMaster Yale Smart Keypad Lever Lock Satin Nickel 1



SET UP YOUR KEY ACCOUNT

Be sure to use SSC's Distributor ID when you sign up to for your account. Get started by going to rewards.liftmaster.com.

SSC Distributor ID: 11215



RESIDENTIAL LIFTMASTER

All Pricing Subject To Change



85870



HD 3/4 HP CHAIN DRIVE ELITE OPERATOR (7', 8', 10', 12', & 14')

WI-FI & BLUETOOTH ENABLED



- Designed for heavier doors such as carriage house doors
- Motor vibration isolation system (MVIS) for quiet operation
- Monitor/control garage door via smart phone or computer* (*WiFi enabled)
- Security+2.0 MyQ®
- 893MAX 3-button Remote
- Lock capable
- Included parts are 858707, 858708, 8587010, 8587012, 8587014.

- 880LMW Smart Control Panel™
- Dual lights with lens covers
- I-Beam rail system
- 2 Speed sprocket 6 and 8 tooth
- Lifetime motor warranty-5-Year parts
- Updated logic board with integrated bluetooth increases processing power and cuts MyQ® connection time.



83650-267



1/2 HP AC CHAIN DRIVE OPERATOR (7', 8' & 10')

WI-FI & BLUETOOTH ENABLED



- Premium series
- Security+2.0 MyQ®
- (2) 893LM 3-button remote control
- 882LMW multi-function control panel
- 877LM keypad
- One-piece rail
- Included parts are 836502677, 836502678, 836526710.

- Dual lights with lens cover (200 watts of light)
- Lifetime motor warranty
- Updated logic board with integrated bluetooth increases processing power and cuts MyQ® connection time.



81650



1/2 HP AC CHAIN DRIVE OPERATOR (7', 8' & 10')

WI-FI & BLUETOOTH ENABLED



- Security+2.0 MyQ®
- 893LM remote control
- 882LMW multi-function control panel
- One-piece rail
- Included parts are 816507, 816508, 8165010

- Single light with lens cover (100 watts of light)
- 4-Year motor warranty
- Updated logic board with integrated bluetooth increases processing power and cuts MyQ® connection time.



81640



1/2 HP AC CHAIN DRIVE OPERATOR (7', 8' & 10')

WI-FI & BLUETOOTH ENABLED



- Security+2.0 MyQ®
- 891LM remote control
- 883LMW multi-function control panel
- One-piece rail
- Included parts are 816407, 816408, 8164010

- Single light with lens cover (100 watts of light)
- 4-Year motor warranty
- Updated logic board with integrated bluetooth increases processing power and cuts MyQ® connection time.



BATTERY BACK UP:

See page 56 for LiftMaster's Integrated Battery Backup System. For use with LiftMaster models 8500W, 87504-267, 87802 & 84602 operators.



• Combine any LIFTMASTER RESIDENTIAL OPERATORS for best quantity pricing



8160W

12V DC CHAIN DRIVE OPERATOR (7', 8' & 10')

- 12V DC motor
- Security+2.0 MyQ® with rolling code technology
- 893LM remote control
- 882LMW multi-function control panel
- Soft start/stop for smooth operation
- California compliant model available (8160WB)



ATSW

¾ HP LIGHT DUTY TROLLEY OPERATOR (8', 10', 12' & 14')

- For residential or light-duty commercial standard-lift sectional doors with light duty cycle requirements up to 14' high
- Ideal for use in pole barns and similar structures for storage and manufacturing
- Up to 8 cycles/hour
- Security+2.0 technology
- I-beam rail system
- Single button control station
- Dual-sided lighting with lens cover
- Protector system photo cells



81550

½ HP AC BELT DRIVE OPERATOR (7', 8' & 10') WI-FI & BLUETOOTH ENABLED



- ½ HP AC motor
- Security+2.0 MyQ® with rolling code technology
- 893LM remote control
- 882LMW multi-function control panel
- Energy-efficient operation. Consumes up to 75% less power in standby mode.
- Included parts are 815507, 815508, 8155010.
- Updated logic board with integrated bluetooth increases processing power and cuts MyQ® connection time.



SET UP YOUR KEY ACCOUNT

Be sure to use SSC's Distributor ID when you sign up to for your account. Get started by going to rewards.liftmaster.com.

See page 49 for more information.

SSC Distributor ID: 11215



RESIDENTIAL LIFTMASTER

This page contains new product!



All Pricing Subject To Change



98022

WALL MOUNT OPERATOR

- Elite Series for residential doors up to 14'H
- Security+2.0® ; anti-burglary coding
- 893MAX 3-button remote
- 824LM remote light
- 880 LMW smart control panel
- 841LM automatic garage door lock
- 485LM EverCharge® Standby Power
- MyQ® technology enables control of door via your smart phone, tablet or computer
- Lifetime motor warranty
- 5-year parts warranty
- California SB-969 compliant



PART 480LM
Alternative Mounting Kit For
3800/8500 Operators 1



DDO8900W

LIGHT DUTY COMMERCIAL DOCK DOOR OPERATOR

- For commercial applications requiring full vertical lift, sectional doors (up to 14' high and 18' wide but not exceeding 180 sq. ft or 300 lbs) with light-duty cycle requirements
- Monitor up to 5 external sensors around door with MyQ Business Facility
- Mounted either left or right side of door
- 12V DC Motor
- Security+2.0® rolling code technology
- Protector System safety reversing sensors
- LMi5 Accessory interface
- 3 button control station
- 6' power cord
- Battery backup capable (*not included*)



PART 3950CG

Chain Guard For 3950 and LJ8950W Operators

1

LET'S LEARN MORE

ABOUT INSTALLING LIFTMASTER'S OPERATORS

Watch these easy-to-follow videos for a quick reference on how to install LiftMaster's new residential operators WLED and 8500W



WLED
INSTALLATION



8500W
INSTALLATION



SET UP YOUR KEY ACCOUNT

Be sure to use SSC's Distributor ID when you sign up to for your account. Get started by going to rewards.liftmaster.com. See page 49 for more information.

SSC Distributor ID: 11215



RESIDENTIAL & LIGHT DUTY COMMERCIAL LIFTMASTER

All Pricing Subject To Change



WALL CONSOLE FOR LIFTMASTER RESIDENTIAL OPERATORS

- Controls garage door and turns operator lights on/off from inside garage
- Illuminated push button
- Locks out all outside radio signals while you're away

PART 78LM

Multi-Function Control Panel
1 6 12

- For use as secondary control panel only
- Turns opener light on/off from inside garage
- Auxiliary button can be programmed to open and close a second door

PART 378LM

Wireless Control Panel
1 6 12



- Compatible only with LiftMaster® Security+2.0 MyQ® garage door openers
- Motion detector automatically turns on the light when movement is detected
- Program remote controls and MyQ® enabled accessories directly from the control panel
- Timer-to-Close feature automatically closes the garage door after a pre-programmed number of minutes

PART 881LMW (WIFI)
Motion Detecting Control Panel with
Timer To Close Security+2.0®

1 6 12



- Adjustable light timer option
- Equipped with the Maintenance Alert System to help keep your system in peak working order
- Easily program remote controls and MyQ® enabled accessories directly from the control panel
- Compatible only with LiftMaster® Security+2.0 MyQ® garage door openers

PART 882LMW (WIFI)
Multi-Function MyQ® Control Panel
Security+2.0®

1 6 12



- Completely wireless - powered by (1) 3-volt battery (included)
- Includes a push button for garage door operation
- Controls opener lights
- Compatible only with Security+2.0 MyQ® LiftMaster® garage door openers enabled by MyQ® technology

PART 885LM
Wireless Control Panel MyQ
Security+2.0®

1 6 12



- Push button for garage door operation
- Motion detector automatically turns on the light when movement is detected
- 150° sensing angle for motion sensor
- Light run-time is 4½ minutes w/adjustable light timer option
- Compatible only with LiftMaster® Security+2.0 MyQ® garage door openers

PART 886LMW
Motion Detecting Control Panel
Security+2.0®

1 6 12



- Upgrades all Chamberlain, Craftsman and LiftMaster models 1998 - present to Security+2.0 MyQ® technology
- Timer-to-Close feature allows the door to automatically close after a pre-programmed number of minutes
- Easily program remote controls and MyQ® enabled accessories directly from the control panel
- Pair with 828LM Internet Gateway

PART 889LM
MyQ® Control Panel

1 6 12



RECEIVER RESIDENTIAL

- Compatible with LiftMaster Security+® remote controls
- Accepts up to 8 Security+ remotes or 1 DIP switch and 12 Billion code remote controls and 1 keyless entry code
- Built-in transformer, plugs into standard polarized 120V, 60 Hz AC outlet
- 2-conductor bell wire included
- Built-in door control button

PART 365LM
Universal Plug-In Receiver,
Security+2.0® (315MHz)

1 24 48



MAX REMOTE CONTROL

- Controls up to three garage doors and operates MyQ® enabled lighting accessories
- Fits in purse, pocket or on a key chain
- Compatible with all LiftMaster openers manufactured since January 1993

PART 890MAX
3-Button Mini Remote

1 6 48



PART 893MAX
3-Button Remote

1 6 48



REMOTE UNIVERSAL

PART 374UT
LiftMaster Mini Universal Transmitter

1 6 24



- See page 76 for full information

PART 380UT
2 Button Universal Remote

1 6 48



SECURITY+2.0®

- LiftMaster 1-button programmable DIP switch remote for use with Security+2.0® 315 MHz DIP and 390 MHz DIP devices.
- Default setting is for Security+2.0®
- Replaces 811LM, 361LM, 61LM
- LiftMaster 3-button programmable DIP switch remote for use with Security+2.0® 315 MHz DIP and 390 MHz DIP devices.
- Default setting is for Security+2.0®
- Replaces 813LM, 333LM, 33LM

PART 811LMX
1-Button Programmable Dip Switch
1 6 48

PART 813LMX
3-Button Remote
1 6 48



- Controls one garage door and operates MyQ® enabled lighting accessories
- Compatible only with Security+2.0® garage door operator

PART 891LM
1-Button Remote
1 6 48

- Ideal for gated communities - one button can control the gate operator, the other can control the garage door opener
- Each button is independently compatible and programmable to Security+2.0® Tri-Band (310/315/390 MHz), Security+ 315 MHz or Security+ 390 MHz
- Each button can also clone any LiftMaster DIP code remote control (811LM, 61LM or 361LM)

PART 892LT
2-Button Remote
1 6 48



- Controls up to three garage doors and operates MyQ® enabled lighting accessories
- Compatible only with Security+2.0® garage door operator

PART 893LM
3-Button Remote
1 6 48

- Ideal for gated communities - one button can control the gate operator, the other can control the garage door opener
- Each button is independently compatible and programmable to Security+2.0® Tri-Band (310/315/390 MHz), Security+ 315 MHz or Security+ 390 MHz
- Each button can also clone any LiftMaster DIP code remote control (811LM, 61LM or 361LM)

PART 894LT
4-Button Remote
1 6 48



SECURITY+315 MHz

- Security® rolling code technology
- 3V lithium battery included

PART 371LM
1-Button Remote
1 6 48

PART 373LM
3-Button Remote
1 6 12



390 MHz SECURITY+ REMOTE

- Security+® rolling code technology
- 3V lithium battery included

PART 971LM
1-Button Remote
1 6 48





KEYPAD

- Open or closes garage door using a private 4-digit code
- Program temporary access codes for visitors and delivery personnel
- 1-button to close feature

PART 877LM
Wireless Keyless Entry, S+2.0®
1 6 48

- ▶ Compatible only with Security+2.0® garage door openers



PART 387LM
Universal Wireless Keyless Entry
1 6 48

- ▶ Single manufacturer/single frequency design
- ▶ You pick the manufacturer and frequency for the garage door you want to open
- ▶ Backlit keypad, weatherproof, slide-up protective cover



OPERATOR ACCESSORIES

- For interior residential operator use
- Sturdy, durable gray plastic

PART PB1
Residential Push Button PB-1
1 3 6

- Compatible only with Security+2.0® with MyQ® Technology

PART 883LMW
Door Control Button
1 6 12



PART 878MAX
Wireless Keypad
1 6 48

- ▶ Compatible with Liftmaster openers manufactured since 1993
- ▶ 1-button to close feature compatible with LiftMaster openers manufactured since 2006



PART VKP1-LMMC
myQ Video Keypad Pro 1

- ▶ Wireless setup with rechargeable battery
- ▶ Receive real-time notifications and view history of when your garage has been accessed
- ▶ Create unique PIN codes and schedule access for guests



- For use with LiftMaster models 8500W, WLB8550W, WLED, 8580WLB and 8360WLB operators

PART 485LM
Integrated Battery Backup System 1



- Position on ceiling in the garage
- Provides 200 watts of light with adjustable time delay
- Controlled by operators activation or control panel light button

PART 380LM
380LM Remote Light For 3800/8500/3900/3950 1



- May be needed if you are unable to program a HomeLink® system to a new Security+2.0® operator
- Contains a repeater and new remote
- The repeater accepts and converts a non-compatible HomeLink® signal into Security+2.0® compatible
- Only compatible with vehicles equipped with HomeLink®
- Programs to several Security+2.0® garage door openers

PART 855LM
HomeLink Repeater Kit
1 12 24



- Easily mounts on ceiling or wall within 6 feet of a 120V electrical outlet
- Can be programmed to turn on and off at certain times through the MyQ® App
- LED bulbs require no maintenance
- 1,500 lumens
- Programmable to work with any MyQ®

PART 827LM
MyQ® Remote LED Light 1





INSTALLATION ACCESSORIES

• All white with male and female plug

PART EC3
3' 18 AWG 3 Wire Flat with Ground 1

PART EC15
15' 18 AWG 3 Wire Flat with Ground 1

PART EC25
25' 18 AWG 3 Wire Flat with Ground 1



PART 3950CG
Chain Guard For 3950 and LJ8950W Operators 1



PART 480LM
Alternative Mounting Kit For 3800/8500 Operators 1



PART 197LM
Wire Channel for T-Rail (100-5'pieces /box) 1



PART 41B42451
Liftmaster 6 Foot Power Cord Kit 1



MYQ® ENABLED ACCESSORIES



• Controls up to 2 doors
• Use your smart phone or computer to operate your garage door and lights
• Compatible with Security+2.0® garage door openers and accessories

PART 828LM
Internet Gateway, Security+2.0® 1

• Enables up to 16 myQ devices
• Monitor, open and close garage door from anywhere and control home lighting all from any device
• Works with most brands of garage openers manufactured after 1993 that use photoelectric sensors that do not shut off
• Includes WIFI hub and door sensor

PART 821LMCS
Universal Smartphone Garage Door Controller 1



• Compatible with Apple Homekit and Siri Voice Control

PART 819LMB
LiftMaster MyQ® Home Bridge 1



WIRE-HIDE WALL PLATE KIT

• Provides a clean and fast solution to protect exposed low voltage wiring
• Ideal for a 2 wire set up. Includes installation hardware and 22" of tubing

PART WH163
Wire Hide Wall Kit in White 1 20 60

PART WH164
Wire Hide Wall Kit in Black 1 20 60

• Provides solar shield to help prevent false signals
• Fits most residential photo eyes
• Includes foam inserts
• Ideally used with wire hide wall plate kits

PART WH621
Wire Hide Sensor Shield in White (pair) 1

PART WH624
Wire Hide Sensor Shield in Black (pair) 1



PART WH143
¼" x 16' Bulk tubing White 1

PART WH144
¼" x 16' Bulk tubing Black 1





PURPLE SMART BUTTON

FOR 315 MHZ MODELS

• With light socket



PART 41AC050-2M
Logic Board (LB4) 1
▶3265

• Without light socket



PART 41AS050-1
Logic Board (LB12) 1
▶3110 and 3220



PART 41AB050-2M
Logic Board (LB8) 1
▶3280



PART 41AC050-1M
Logic Board (LB17) 1
▶3245 and 3255



PART 41A5021-9G-315
Logic Board 1
▶ATS2113X

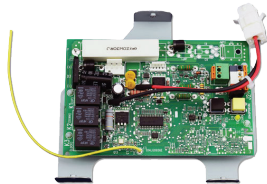

PART 41DJ001
Logic Board (LB19) 1
▶3800, complete with plate



RED SMART BUTTON

FOR 390 MHZ MODELS



PART 41A5021-1HATS
Logic Board 1
▶ATS211X



SCAN TO DOWNLOAD

Scan the QR code for a digital copy of the LiftMaster Logic Board Conversion chart or see page 165 in the back of the catalog



YELLOW SMART BUTTON



PART 41DJ002
Logic Board 1
▶8500



PART 45DCT
Logic Board 1
▶8360 and 8550



PART 45ACT
Logic Board 1
▶8355, 8557, 8587, 8165, 8365, 8065



PART 050DCTB
Logic Board 1
▶84501, 84602, 87504-267, 84505R



PART 050ACTBMC
Logic Board 1
▶8355W, 8587W, 8557W, 8365W, 8165W and 8155W



PART 050ACTWFATS
Logic Board 1
▶ATSW



PART 050DCRJWF
050DCTWF Control Board 1



GATE LOGIC BOARD

• Special orders



PART K001A6039
LA400 Control Board 1

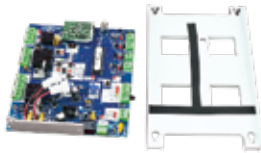

PART K1A6426-1
LA412 Control Board 1



PART K1D7545CC
LA500 Control Board 1



PART K1D8052-1CC
LA400DC Control Board
LA412DC Control Board
LA500DC Control Board 1





SAFETY SENSOR KIT

- Replaces LiftMaster 41A503 Snappy Sensors
- For use with various LiftMaster® and Chamberlain® Belt Drive and Chain Drive Garage Door Openers featuring myQ® technology and Secure View™ Video Camera, manufactured after 1997
- Includes: Sending sensor (with LED), receiving sensor (with LED, 2-conductor wire, (5) wire connectors, and replacement hardware *(does not include brackets 410155)*
- Will work with the older style brackets

- LiftMaster Part# 41-0155-000
- Only compatible with new safety reversing sensors 410136

PART 410155
Safety Sensor Brackets - 2021 to Present 1

- LiftMaster Part# 41A5266-1
- Compatible with all LiftMaster operators with safety sensors (1997 - current)

PART 41A526
Brackets For Snappy Sensors 1

- Extension brackets provide additional clearance for wall mounting or additional height for floor mounting

PART 41A5281
Snappy Sensor Extension Brackets 1

PART 410136
Safety Sensors 1



RPM SENSOR



TROLLEY ASSEMBLY

PART 41D7742
Travel Module 1

- LiftMaster Part# 41A6262

PART 41A626
Trolley Assembly, 3-Piece Rail 1

- LiftMaster Part# 41A3489
- For LiftMaster chain drive openers from 1984 - present

PART 41A348
Trolley Assembly, T-Rail 1

- LiftMaster Part# 41C4677
- For all LiftMaster screw drive operators 1995 - current

PART 41C467
Screw Drive Trolley Assembly 1



PART 41C4672
Screw Drive RPM Sensor Assembly 1



- LiftMaster Part# 41C5141-1

PART 41C514
Square Rail Trolley Assembly 1



- LiftMaster Part# 41B3869-1

PART 41B386
Trolley Assembly, Belt Drive 1270 1



PART 41C4398
RPM Sensor Assembly 1



GEARS & SPROCKETS

- LiftMaster part# 41C4220A
- Includes: spring washer, thrust washer, retaining ring, bearing plate, (2) roll pins, drive and worm gear, helical gear with retainer and grease

PART 41C422
Chain Drive Gear and Sprocket Assembly
1 18

- LiftMaster part #41A4885-2
- Includes: spring washer, thrust washer, retaining ring, bearing plate, (2) roll pins, drive and worm gear, helical gear with retainer and grease
- For belt drive models 1984-2001

PART 41A482
Belt Drive, Drive Gear and Sprocket Assembly Pre-2001 1

- LiftMaster part# 41A4885-5
- Includes: spring washer, thrust washer, retaining ring, bearing plate, (2) roll pins, drive and worm gear, helical gear with retainer and grease
- For belt drive models after 2001

PART 41A485
Belt Drive, Drive Gear and Sprocket Assembly After 2001 1

- For use with LiftMaster 8500 operator
- PART 41B8861**
Absolute Encoder/Travel Module 1



- For dual sprocket assemblies
- LiftMaster part# 41A326-1
- Models 1246, 1256 and 1356

PART 41A3261
Dual Gear Assembly 1



- Works with models 2575, 3575, 3275 and ATSW

PART 41A5585
3/4 HP Chain Drive Gear and Sprocket Assembly 1



- LiftMaster part# 41C4470
- For ATS opener
- Includes: spring washer, thrust washer, retaining ring, bearing plate, (2) roll pins, drive and worm gear, helical gear with retainer and grease
- Only works with models ATS211 and ATS211R

PART 41C4470
LiftMaster Gear and Sprocket 1



- For ATS211X and ATS2113X
- LiftMaster part# 41A5668
- Only works with models ATS211X and ATS2113X

PART 41A5668
Gear and Sprocket Assembly for ATS 1



- Works with models 2595 and 3595

PART 41A5658
3/4 HP Chain Drive Gear and Sprocket Assembly 1



- LiftMaster part# 41A2817
- For LiftMaster chain drive openers from 1984 - present
- Includes gear, plastic worm, grease, roll pins, washers and retaining rings

PART 41A281
Drive/Worm Gear Kit
1 18 36



- Holds shaft assembly for easy removal of roll pins
- Makes changing gears easy
(Gear not included)

PART 809
Gear Master 1



POWER DOOR LOCK

- Performs in tandem with the opener, so it always locks and unlocks.
- Powered by MyQ® technology
- A deadbolt lock reinforces the garage door automatically when closed.
- The sound of the lock engaging provides homeowners with the assurance the garage door has been secured.

PART 841LM
Automatic Garage Door Lock

1



CAPACITOR

- Compatible with ½ HP residential operators
- Same as model 30B363

PART 30B532
Motor Capacitor 56 MFD 1



MISCELLANEOUS PARTS

- LiftMaster part# 41A2780
- For use with LiftMaster model ATS, 2595,3595, and various chain-drive operators.

PART 41A278
Chain Sprocket Bracket Assembly

1

- LiftMaster part# 41A35881
- For Models 1270, 1280 and 1280R

PART 41A35881
Belt Pulley Bracket Assembly Old Style

1

- LiftMaster part# 41A4813
- For full chain openers 1990-current

PART 41A481
Sheave Bracket Assembly

1

- LiftMaster part# 41B5424
- For all newer belt drive rails

PART 41B5424
Belt Pulley Bracket Assembly New Style

1



- LiftMaster part# 81C168
- Works in conjunction with carriage trolley #41C4677

PART 81C168
Rack For Screw Drive

1

- LiftMaster part# 81C275
- For use with 3-piece rail assembly

PART 81C275
Rack For Screw Drive

1

PART 25C20
LiftMaster Screw Drive Coupling

1

- LiftMaster part# 41D3452
- For chain drive and some belt drive openers from 1994 to current

PART 41D345
Limit Switch Assembly

1



- For use with most residential chain/belt operators featuring a 660W light socket on end panel.
- Also known as 41C279, 004A1344, 175C0279

PART 41C0279
Light Socket - Residential

1



REPLACEMENT BELT

- 2001 or before

PART 41A35893
7' Replacement Belt

1

PART 41A35891
8' Replacement Belt

1

PART 41A35892
10' Replacement Belt

1

- 2002 or after

PART 41A543411
7' Replacement Belt

1

PART 41A543413
8' Replacement Belt

1

PART 41A543414
10' Replacement Belt

1

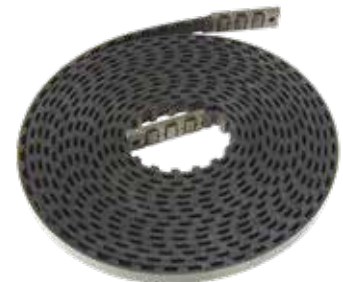



LDC0841

DC LED BELT OR CHAIN DRIVE OPERATOR (7' & 8')



LDC0863B

DC LED BELT OR CHAIN DRIVE OPERATOR (7' & 8')

California Compliant Model Including Battery Backup

- The smart operator with an ultra-quiet, energy-efficient, DC-powered motor
- (1) Energy-efficient long life LED light panel (LDC0863B includes 3)
- Spott technology provides monitoring and control anytime, anywhere with Wi-Fi connectivity
- Battery backup optional (not included) *California Compliant model below*
- Includes one MTS3 3-button remote and Wi-Fi multi-function wall control station

WIFI



LDC0801

800 NEWTON DC BELT & CHAIN DRIVE POWERED OPERATOR (7' & 8')

- Battery backup compatible
- Intelligent, self-learning, self-adjusting, torque settings
- Low-power standby mode reduces energy consumption
- Supplies 800 Newtons of lifting force for heavy doors



LDO50

1/2 HP BELT AND CHAIN DRIVE OPERATOR (7' & 8')

- Compatible with belt-drive or chain-drive
- 100-watt light (*bulb not included*)
- Built-in MegaCode format receiver
- Operator includes (1) three-button MCT-3 visor transmitter and deluxe wall station
- BELT DRIVE: Lifetime motor and belt warranty, 5-years mechanical parts warranty, and a 1-year electrical warranty.
- CHAIN DRIVE: Lifetime motor warranty, 5-years chain rails and mechanical parts warranty, and a 1-year electrical warranty.



BATTERY BACKUP

- Linear Battery Back-up

PART LINBBU
1/2 HP Chain and Belt Drive

1



LINEAR REMOTE

- 318 MHz
- Smart button programming
- Includes (1) CR2032 battery and visor clip

PART DNT00091
1 Button Remote MTS-1

1 10 25

- 318 MHz
- Smart button programming
- Replaces MTR3

PART DNT00093
3 Button Remote MTS-3

1 10 25

- 318 MHz
- Smart button programming
- (2) 3-volt batteries and quick disconnect key ring included

PART ACP00607
1 Button Key Ring Remote ACT-21

1 10 25

RESIDENTIAL
LINEAR

LINEAR

This page contains
new product!



All Pricing Subject To Change



VISOR REMOTE

- Compatible with 310 MHz Stanley and multi-code receivers
- Easy access to battery and coding switches

PART 105015

1-Button Stanley and Multi-Code Remote
1 10 25



MEGA CODE 3 BUTTON REMOTE

- 318 MHz
- Includes (1) CR2032 battery and visor clip.

PART DNT00093

3 Button Remote MTS-3
1 10 25



LINEAR PARTS

- Compatible with MultiCode, Delta 3 and MegaCode
- Includes: wires, connectors and instructions

PART HAE0002

Linear Photocell Kit
1 10 25

- Compatible with LS050, LD033 and LD050 operator

PART HAE00001

Deluxe Wall Station
1 10 25

- Compatible with LS050, LD033 and LD050 operators
- Replaces Part# HAE00003 and HAE00039

PART HAE00040

Control Board 1

- Compatible with LS055, LD033 and LD050 operator

PART HAE00047

Helical and Worm Gear 1



DELTA 3

- 310 MHz
- 8 rocker switch programming
- 9-volt battery and visor clip included

PART DNT00002A

1 Button Remote DNT
1 10 25

- 310 MHz
- 8 rocker switch programming
- Mounting bracket included
- 24-volt, three terminal

PART DNR00001

1 Channel Receiver 1



KEYLESS ENTRY

- 310 MHz
- Activate multiple Delta 3 receivers
- Mounting hardware included

PART DNT00062

DTKP Wireless Keyless Entry
1 10 25

- 318 MHz
- For use with LDC0850/852

PART LPWKP

Mega Code Wireless Keypad
(LEFT IMAGE)

PART DNT00094

Mega Code Keypad Transmitter-NMTK
(RIGHT IMAGE)
1 10 25





1,988 YEARS OF SERVICE INSTALLED IN EVERY ONE.

Not only is Guardian one of the largest, most vertically integrated manufacturers of garage door openers and related hardware in the world.

We back it all up with service second to none.

We are at our best when you need it the most.

You should see what we're doing now.

adhguardianusa.com

Call SSC to place your order!
servicespring.com | 833.SSC.DOOR



928DC

12 V DC LIGHT-DUTY OPERATOR

- Smooth and quiet DC motor
- Compact and space saving
- Designed to open residential doors up to 18' wide x 14' high and 850 lbs.
- 1500 Lumen built in courtesy LED lighting
- HOMELINK® compatible with all vehicles on the road today
- (1) 3-button remote control, (1) deluxe door control console, (1) automatic garage door lock, (1) cable tension monitor
- Lifetime motor warranty, 5 year warranty on parts, 1 year warranty on accessories
- Battery back-up capable (not included)



415CC

1/2 HP CHAIN OR BELT DRIVE OPERATOR

- Powerful 1/2 HP AC motor
- Available with a heavy-duty chain drive or durable belt drive
- Maintenance-free rail system does not require periodic lubrication
- 100W courtesy lighting
- 5-year motor and 1-year parts warranty



615CC

1/2 HP CHAIN OR BELT DRIVE OPERATOR

- Quiet 1/2 HPe DC motor
- Available with a heavy-duty chain drive or durable belt drive
- 100W courtesy lighting
- 5-year motor and 1-year parts warranty
- Maintenance-free power train and rail system does not require periodic lubrication



628CC

3/4 HP DC CHAIN OR BELT DRIVE OPERATOR

- 3/4 HPe DC motor for extra power to lift heavier doors
- Available with a heavy-duty chain drive or durable belt drive
- 200W courtesy lighting
- Lifetime motor and 1-year parts warranty
- Maintenance-free power train and rail system does not require periodic lubrication



715BBU

1/2 HP DC CHAIN OR BELT DRIVE OPERATOR

- 1/2 HPe DC motor
- Includes battery backup
- Available with a heavy-duty chain drive or durable belt drive
- 100W courtesy lighting
- 5-year motor and 1-year parts warranty



REMOTES

- 303MHz/390MHz dual frequency burst
- Compatible with any Guardian 303MHz or 303 MHz/390MHz dual frequency agile receiver
- Includes: 1 x CR3032, 3V button cell battery & visor clip
- 200 ft. operating range
- 4 million codes per button

PART D1B

Deluxe 1 Button Remote Control

1	6	24
---	---	----

PART D3B

1	6	24
---	---	----

PART D2B

Deluxe2 Button Remote Control

1	6	24
---	---	----



KEYPAD

- 303MHz/390MHz dual frequency burst
- Up to 6 digit programming, 1 million different combinations are possible
- Includes: (2) AAA batteries, Mounting screws and anchors

PART WKCC

Guardian Wireless Entry Keypad

1	6	24
---	---	----



WALL CONSOLE

PART FDCC-1

Guardian Door Control Console (left image)

1

1

1

our people define us

“I think it’s always best to just be yourself and be positive. It really helps with the person on the other end of the phone.”
– Lorena P., Inside Sales

Over 60 years of having the right people in place not only helps us grow but allows us to manufacture products of the highest quality.

SSC...over 60 years of innovation that’s uniquely better.



servicespring.com | 833.SSC.DOOR

Follow us:     



**RESIDENTIAL
GUARDIAN**

67

All Pricing Subject To Change

Synergy Door Openers

Engineered for Safety,
Performance & Reliability

- + Pretensioned ultra-quiet belt drive
- + Remote access systems
- + Integrated LED lighting
- + Battery Backup Optional
- + HomeLink™ Compatible
- + Maveo BluFi Compatible
- + Quick and easy to install

Make life a little bit easier by upgrading to
Synergy Series premium residential door
openers.

NEW



maveo

Brings Wi-Fi connectivity
to your residential
garage door openers

Contact us today to learn more.
833.SSC.DOOR | SERVICESPRING.COM

marantec 
engineered for you



300 Series

Synergy 370 850N, 3/4+ HPCS

Our most popular and fastest door opener. Ideal for insulated and many other garage door types.

Synergy 380 1,100N, 1.1 HPCS

Our most powerful door opener. Designed for carriage-house, wind-loaded, or heavy glass garage doors.

Limited lifetime, warranty on motors, gears & rail systems Up to a 8 year warranty on



200 Series

Synergy 270 750N, 3/4 HPCS

Versatile and reliable performance. Ideal for most types of residential garage doors.

Synergy 280 1000N, 1 HPCS

Designed for use with most garage door types, including double garage doors or wind-loaded doors.

Limited lifetime, warranty on motors, gears & rail systems Up to a 4 year warranty on



270 BELT DRIVE OPERATOR (7', 8', & 10')

- Push/pull force: 750N (¾ HPCS)
- Door speed: 6.3 in/sec
- Built in LED lighting
- Includes (1) 122436 and (1) 89463
- 4 year parts warranty
- 5 year LED warranty
- Optional battery back up



280 BELT DRIVE OPERATOR (7', 8', 10', 12', & 14')

- Push/pull force: 1000N (1.0 HPCS)
- Door speed: 6.3 in/sec
- Built in LED lighting
- Includes (1) 122436 and (1) 89463
- 4 year parts warranty
- 5 year LED warranty
- Optional Battery Back Up



370 BELT DRIVE OPERATOR (7', 8', & 10')

- Push/pull force: 850N (¾+ HPCS)
- Door speed: 9.3 in/sec
- Built in LED lighting
- Includes (1) 122989 and (1) 89463
- Optional battery backup
- Optional timer-to-close
- 8 year parts warranty
- 5 year LED warranty



380 BELT DRIVE OPERATOR (7', 8', 10', 12', & 14')

- Push/pull force: 1100N (1.1 HPCS)
- Door speed: 7.1 in/sec
- Built in LED lighting
- Includes (1) 122989 and (1) 89463
- Optional Battery Backup
- Optional Timer-to-Close
- 8 year parts warranty
- 5 year LED warranty
- Requires 1.2 mm rail



REMOTES

- Mini Remote Transmitter (315 MHz)

PART 122436
2 Channel Transmitter
1 6 24

- Visor Size Remote Transmitter (315 MHz)

PART 122468
4 Channel Transmitter
1 24 48

PART 122989
4 Channel White Glossy Transmitter
1 24 48



WALL CONSOLE

PART 89463
Deluxe Wall Console
1 24 48



KEYPAD

PART 104053
External Digital Entry System
1 6 24



LED LIGHTING KIT

- LED lighting system
- 378 lumens expandable to approximately 756 lumens

PART 101160
EL 200 Series LED Lighting Kit 1

- LED lighting system
- 500 lumens expandable to approximately 1,100 lumens

PART 101161
EL 300 Series LED Lighting Kit 1



OPERATOR ACCESSORIES

PART 165917
Wireless Wall Station 1

PART 97246
Replacement Photo Eyes
1 24 48

PART 104586
Integrated Battery Backup For 200 and 300 Series 1

PART 75424
Marantec External Receiver 315 MHz 1

PART 97110
Marantec External Receiver 916 MHz 1





- Max weight 850 lbs with or without BBU
- Max sq. footage 180
- Max door height 14'
- Max door width 18'
- Up to 84" of high lift and does full vertical or low headroom (inside hook up only)

 **6070H**
24V DC WALL MOUNT

 **6170HB**
24V DC WALL MOUNT
W/BATTERY BACKUP



 **DUAL FREQUENCY REMOTE**

- 315/390 MHz - Intellicode 2

PART 37218R
3 Button G3T-BX Remote
(315/390MHz)
1 25 50



 **UNIVERSAL KEYPAD**

- GKBX will operate up to 3 doors
- Compatible with OHD Code Dodger systems
- Auto-seek frequency technology

PART 37224R
Intellicode 2 Wireless Keypad (GKBX)
1 25 100

- Keypad with ribbon cable

PART 20235R
Replacement Keypad for
Wired Kep-1 1



 **REMOTE**

- Auto seek dual frequency 315/390 MHz
- Works with all Genie gated community receivers
- Works with Genie 9 switch and 12 switch units
- Intellicode 1 and 2 compatible

PART 37344R
3 Button Universal GM3T-BX
Remote (315/390MHz)
1 25 50



PART 38501R
1 Button G1T-BX Intellicode
(315/390MHz)
1 25



- Works with most major brands sold in the USA
- Pre-programmed settings with LED light for easy programming
- Recognizes an existing opener remote transmission

PART 40659R
4 Button Universal GU4T-BX Remote
1 25 50



 **WALL CONSOLE**

- Lock out, light control and push button in one
- Wall box mountable, OHD Code Dodger compatible

PART 39165R
Deluxe Series II Wall Console GWC-2
1 10



- Multi-Function wall console with light control and Sure-Lock™ that disables remote access

PART 37222R
Deluxe Series III Wall Console
GBWC-3
1 10



- Completely wireless installation
- Works with all Genie Intellicode openers since 2013
- Delay button feature allows up to 30 seconds of time before door movement.

PART 39902R
Wireless Wall Console GWWC-P
1 6



CONTROL BOARDS AND RECEIVERS

FOR GENIE OPERATORS



- 6 terminal
- Replaces 20380R

PART 20380S
Control Board (ICB) 1
• 3 terminal

PART 20285R
Receiver 12 Switch (25648R) 1



• Replaces 20380R
PART 36190T
Control Board (FKA 20380R) 1
• For models post Jan. 2007 to present



- Fits many models
- Newly designed board for Intellicode
- Replaces 20437R, 31171R, 33629R, 35593R, 33629R and 34375R

PART 36521R
Internal Receiver (20437R) 1



- Replaces 34463R and 36428R.S
- Genie DC screw drive

PART 35383R
Excelerator Motor Drive Board 1
• Replaces 34019R, 20424S



- For 1024 Chain and belt drive openers

PART 36448A
1024 Control Board (Genie Pro Black) 1 6



- Replaces 37470R1.S, 37470R2.S, 37470R3.S and 37470R4.S

PART 38877RS
Dual Encoder Control Board 1



- Models: 15D, H800, PRO99 & CMD990 After 2009

PART 36600R
Excelerator Control Board 1^S
• Models: PRO95, CM8600,

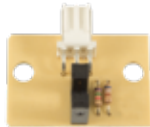

PART 31057R
Screw Drive Opto Luctor 1



• CM7600 & 15550
PART 20386R
Sequencer (31184R) 1



PART 39360RS
Dual Encoder Assembly 1



CARRIAGES

- Works on Genie IntelliG 1000 & 1200 garage door operators

PART 36773R
Genie Carriage Assembly - 7' 1



- Works on Genie IntelliG 1000 & 1200 garage door operators

PART 36773S
Genie Carriage Assembly - 8' 1



- Replaces part# 20414R and 34107R, 25589S, 25589C, 25589R, 20073R and 24357R

PART 36179R
Screw Drive Carriage with Magnet 1 10



- Used with 20462R above, on all belt drive openers
- Also used on chain channel rail systems

PART 27175B
Carriage Slide 1



- Replacement for all Genie T-rail operators
- Genie Part# 20438R and 21784R
- Uses 25605R InnerSlide

PART 36254R
T-Rail Std Carriage Assembly (20438R) 1



PART 36664R
Shuttle Assembly Screw Drive 1



- Compatible with Trilog™ 1200/1500 screw drive
- Works with shuttle assembly 36664R

PART 37845R
Screw Drive Carriage Assembly 1



GENIE CAPACITORS

- For 1/8 HP Genie operators

PART 18004B
Capacitor 50-60 MFD 1



- For 1/2 HP Genie operators

PART 19988A
Capacitor 70 MFD 1



REPLACEMENT PARTS

• Replaces part# 20374T

PART 37220R
GSTB-BX Safe-T-Beam System
1 25 50

PART 34879A
PhotoCell Bracket
Series II (EA) 1

PART 1986AO Collar 1

PART 19807A
Spring Clip 1

• Joins motor to rail assembly
PART 30257T
Coupler For Screw Drive 1

• For all TriloG screw drive models
PART 36645R
Coupler For Screw Drive 1

• Works on all Genie T-rail chain drive operators
PART 25605R
Inner Slide - Chain Drive 1

PART 34516R
Inner Slide ML Models
with Magnet 1

• Mounts to door, arm mounts to bracket
PART 19792A04
Genie Door Bracket 1

• Same as Part# 24454R and 19563R
PART 20113R
Limit Switch and Screw 1

PART 27150A
Bullet - Chain 1

PART 28018A
Bullet - Belt 1

• Can be used with other brands
PART 26013D
Curved Door Arm 1

• Can be used with other brands
PART 26012D
Straight Door Arm 1

• 12 Pack
PART 34439S
PhotoCell Bracket Extension
Series II 1

• 1' wire for splice
PART 20302R
PhotoCell Connector Pigtail 1

• 1 $\frac{3}{8}$ " W - white wire
• Chain glide
PART 34538R
Up Limit Switch Wide
Magnetic 1

• 1 $\frac{3}{8}$ " W - brown wire
• Chain glide
PART 34538S
Down Limit Switch
Wide Magnetic 1

• Former Part# 22668A04
PART 35421A
Header Bracket 1

• 3 Pack, external, chain mounted
PART 24701R
Chain Dog Set Of Three 1

• 3 $\frac{1}{4}$ " W - white wire
• Genie excelerator
PART 33950R
Up Limit Switch
Narrow Magnetic 1

• 3 $\frac{1}{4}$ " W - brown wire
• Genie excelerator
PART 33950S
Down Limit Switch
Narrow Magnetic 1

• Universal power supply by Genie
• Complete with bell wire
PART 2278
110V - 24V Transformer
with Bell Wire 1

PART 27096A
Genie Drive Gear 1





REMOTE

MULTI-CODE COMPATIBLE, 300 MHZ - 10 BINARY SWITCHES

• 9V battery included

PART DC5010

1-Button Remote
1 25 50

PART DC5060

2-Button Remote
1 25 50

PART DC5030

3-Button Remote
1 25 50



• 12V battery included

PART DC5040

1-Button Mini Remote
1 25 1 50

• 310 MHz Stanley and Multi-Code compatible
• 9V battery included

PART DC5012

1-Button Remote
1 25 50

• 310 MHz Stanley and Multi-Code compatible
• 12V battery included

PART DC5042

1-Button Mini Remote
1 25 50



KEYLESS ENTRY

• 9V battery included

PART DC5200

Wireless Keyless Entry
1 10 25

- 300 MHz
- Works on all Digi-Code receivers, flip lid
- Multi-Code compatible, flip lid

PART DC5202

Wireless Keyless Entry 1

- 310 MHz
- Stanley compatible, flip lid
- 9V battery included



PHOTO CELL UNIVERSAL

- Works with ALL major brands of operators including: Chamberlain, LiftMaster, Craftsman, Genie, Overhead (1995+), Challenger, Stanley, Linear, and Moore-O-Matic models
- Includes brackets and hardware

PART CR2149

Universal Photocell Kit
1 10 25



RECEIVER

300 MHz MULTI-CODE COMPATIBLE, 10 BINARY SWITCHES

- 6"W x 3 1/8"H x 1 1/4"D
- 10 Rocker switches

PART DC5100

24V 3 Tab Receiver
1 25 50



RADIO SET

- Includes: DC5100 receiver and DC5010 remote
- Multi-Code compatible
- 300 MHz, 10 Binary switches

PART DC2002

2 Car Radio Set
1 25 50

mix&match

- Combine any REMOTE, KEYLESS ENTRY AND WALL CONSOLE for best quantity pricing

RESIDENTIAL DIGI-CODE

All Pricing Subject To Change



300 MHz RECEIVER

- 3 TAB - 10 Binary dip switches

PART 109020
24V 1-Channel Receiver 1090-20
1 25 50



- Includes: coaxial fitting, antenna and power supply

PART 109920
110V 1-Channel Receiver 10990-20
1 25 50

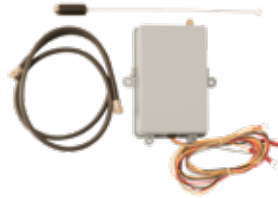

- Dual frequency 300-310 MHz
- 3' coaxial cable, antenna and bulkhead connector
- 12-24V AC or DC

PART 109950
12-24V 1-Channel Receiver 1099-50
1 25 50

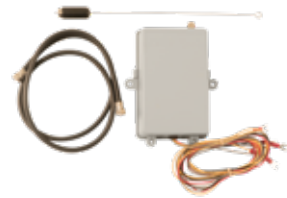

- Dual Frequency 300-310 MHz
- Includes: 3' coaxial cable, antenna and bulkhead connector
- 12-24V AC or DC

PART 302850
12-24V 2-Channel Receiver 3028-50
1 25 50



- Works with all F type con. receivers
- Includes: 15' coaxial cable, antenna and mounting bracket

PART DC5166
Remote Antenna Kit 1



REMOTE

- 9V battery included

PART 308911
1-Channel Remote 3089
1 25 50



PART 412001
2-Channel Remote 4120
1 25 50



PART 414001
4-Channel Remote 4140
1 25 50



RADIO SET 300 MHz



300 MHz-10 BINARY DIP SWITCH DESIGN

- Includes: 109020 receiver and 308911 remote

PART 202200
2 Car Radio Set 2022
1 25 50



- 1½" W x 2" H x 5/8" D
- 12V Batteries included

PART 307010
1-Channel Remote
1 25 50



- 1½" W x 2½" H x 5/8" D
- 12V Batteries included

PART 306010
1-Channel Remote
1 25 50



- 1½" W x 2½" H x 5/8" D
- 12V Batteries included

PART 308301
2-Channel Remote
1 25 50



KEYLESS ENTRY

- 2¾"W x 6¼"H x 1"D
- 4-digit pin code access
- Tamper-resistant and weatherproof
- 9V battery included

PART 420001
Wireless Keyless Entry 4200
1 25 50

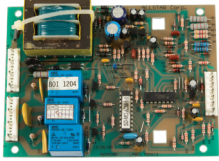

CONTROL BOARD CHALLENGER

• For AC9300, AC9500

PART 190109938
Motor Control Board 1



REMOTE 318 MHz 9V BATTERY INCLUDED

PART 109391
1-Button Remote BA9931MT
1 10 25
•9 switch-trinary dip switch



mix&match

• Combine any REMOTE, KEYLESS ENTRY AND WALL CONSOLE for best quantity pricing

**RESIDENTIAL
ALLSTAR**

75

All Pricing Subject To Change



REMOTE HEDDOLF

- 9 trinary dip switches
- Overhead compatible
- 9V battery and visor clip included

PART 220340

1-Button Remote - 340MHz
1 25 50

PART 220360

1-Button Remote - 360MHz
1 25 50

PART 220390

1-Button Remote - 390MHz
1 25 50



REMOTE UNIVERSAL

- Control two different garage door manufacturers and/or frequencies at the same time
- Compatible with: Genie, Linear/Moore-O-Matic, Stanley, Wayne Dalton, Craftsman, Chamberlain, LiftMaster, 300 MHz, 310 MHz, 315 MHz, 372 MHz, 390 MHz systems
- 3V lithium battery included

PART 380UT

2-Button Universal Remote
1 6 48



- Allstar compatible
- 9V battery and visor clip included

PART P220

1-Button Remote - 318MHz
1 25 50

PART 374UT

LiftMaster Mini Universal Transmitter
1 6 24





COMMERCIAL OPERATORS

**RAISING
STANDARDS
TO KEEP YOUR
BUSINESS
RUNNING**

LiftMaster®

servicespring.com | 833.SSC.DOOR



MJ5011U

½ HP 115V COMMERCIAL, MEDIUM DUTY JACKSHAFT OPERATOR

- Universal Install
- ½ HP 115V single phase
- UL325 compliant, built in 315 MHz receiver
- CPS-U commercial photo cell system
- 3 button station, open/close/stop
- 1" bore, 32 tooth sprocket for #41 chain



MH5011UL

½ HP 115V COMMERCIAL, MEDIUM DUTY HOIST OPERATOR



MH5011UR

½ HP 115V COMMERCIAL, MEDIUM DUTY HOIST OPERATOR

- Pictured Left side mount – right hand drive
- ½ HP 115V single phase
- UL325 compliant with built in 315 MHz receiver
- 3 button station, open/close/stop
- CPS-U Commercial photo cell system
- 1" bore, 32 tooth sprocket for #41 chain



J501L5

½ HP 115V COMMERCIAL, CONTINUOUS DUTY JACKSHAFT OPERATOR

- Universal Install
- MyQ® enabled
- ½ HP 115V single phase
- UL325 compliant, Logic 5.0 with built in 315 MHz Security+2.0® receiver
- 3 button station with maintenance alert, open/close/stop



H501L5R

½ HP 115V COMMERCIAL, CONTINUOUS DUTY HOIST OPERATOR

- Right hand mount - left hand drive
- MyQ® enabled
- ½ HP 115V single phase
- UL325 compliant, Logic 5.0 with built in 315 MHz Security+2.0® receiver
- 3 button station with maintenance alert, open/close/stop



COMMERCIAL LIFTMASTER

All LIFTMASTER COMMERCIAL OPERATORS are in-stock and ready to ship from any of our locations!

833.SSC.DOOR | servicespring.com

PHOTO CELL OPTIONS

All operators also available in your choice of the following:

CPS-U, CPS-OPEN4, CPS-RPEN4 and CPS-UN4 see page 84

SPECIALTY OPERATORS

Available upon request
DAMP ENVIRONMENT NEMA4
EXPLOSION PROOF

3 PHASE IN-STOCK H50, H75, T75 & J75



H751L5R

¾ HP 115V COMMERCIAL, CONTINUOUS DUTY HOIST OPERATOR

- Right hand mount - left hand drive
- MyQ® enabled
- ¾ HP 115V single phase
- UL325 compliant, Logic 5.0 with built in 315 MHz Security+2.0® receiver
- 3 button station with maintenance alert, open/close/stop

- CPS-U commercial photo cell system
- 1" bore, 18 tooth sprocket for #50 chain
- Solenoid actuated brake



GH501L5

½ HP 115V INDUSTRIAL DUTY GEAR HEAD HOIST OPERATOR

- Right hand mount - left hand drive
- MyQ® enabled
- ½ HP 115V single phase
- UL325 compliant, Logic 5.0 with built in 315 MHz Security+2.0® receiver
- 3 button station with maintenance alert, open/close/stop

- CPS-U commercial photo cell system
- Solenoid actuated brake



MT5011U

½ HP 115V MEDIUM DUTY TROLLEY OPERATOR (10', 12' & 14')

- For standard lift commercial doors up to 14'H
- ½ HP 115V Single Phase
- Medium duty logic programmable integrated circuit board
- Integrated 3 channel 315 MHz receiver accepts up to 20 remotes

- CPS-U Commercial Photo Cell System
- 3 button station, open/close/stop
- For use on doors with up to 12 cycles per hour usage



T501L5

½ HP 115V CONTINUOUS DUTY TROLLEY OPERATOR (10', 12', 14' & 16')

- ½ HP 115V Single Phase
- CPS-U Commercial Photo Cell System
- Standard with optional upgrade
- UL325 Compliant, Logic 5.0 with built in 315 MHz Security+2.0® receiver
- 3 button station with maintenance alert, open/close/stop

- 18', 20', 22', 24'H operators available by special order
- MyQ enabled



LiftMaster

COMMERCIAL LIFTMASTER

All LIFTMASTER COMMERCIAL OPERATORS are in-stock and ready to ship from any of our locations!

All Pricing Subject To Change



T751L5

3/4 HP 115V CONTINUOUS DUTY TROLLEY OPERATOR
(12', 14' & 16')



GT501L5

1/2 HP 115V INDUSTRIAL DUTY GEAR HEAD
TROLLEY OPERATOR

- MyQ® enabled
- 1/2 HP 115V Single Phase
- UL325 Compliant, Logic 5.0 with built in 315 MHz Security+2.0® receiver
- 3 button station with maintenance alert, open/close/stop

- CPS-U Commercial Photo Cell System
- Solenoid Actuated Brake



LJ8900W

LIGHT DUTY JACKSHAFT OPERATOR



- For standard lift and high lift (7' max high lift) sectional doors up to 14'H and 18'W, but not exceeding 180 sq ft or 650 lbs
- Mounted either right or left side of door
- Heavy-duty 24V DC motor
- 315 MHz receiver
- Protector System® safety photo-sensors

- APBS single button control station (remotes not included)
- 6' power cord
- Rated up to 10 cycles per hour



PART 485LM
Integrated Battery
Backup System

1



PART 827LM
Remote Light

1

►Also available for LJ8950W



LJ8950W

LIGHT DUTY JACKSHAFT OPERATOR



- For commercial rolling sheet doors with live or dead shaft up to 12'H and 14'W and not exceeding 650 lbs
- Mounted either right or left side of door
- Heavy-duty 24V DC motor
- 315 MHz receiver
- Protector System® safety photo-sensors
- APBS single button control station (remotes not included)

- 6' Power cord
- Maximum recommended duty cycle: 10 cycles per hour
- UL325-2010 Compliant
- Chain guard sold separately



COMMERCIAL LIFTMASTER

All LIFTMASTER COMMERCIAL OPERATORS are in-stock and ready to ship from any of our locations!

833.SSC.DOOR | servicespring.com

PHOTO CELL OPTIONS

All operators also available in your choice of the following:

CPS-U, CPS-OPEN4, CPS-RPEN4 and CPS-UN4 see page 84

SPECIALTY OPERATORS

Available upon request
DAMP ENVIRONMENT NEMA4
EXPLOSION PROOF

PHASE 3 IN-STOCK H50, H75, T75 & J75



REPLACEMENT CHAIN

- PART 195810-1**
#48 Drive Chain for 1/2 HP-10' 1
- PART 195812-1**
#48 Drive Chain for 1/2 HP-12' 1
- PART 195814-1**
#48 Drive Chain for 1/2 HP-14' 1
- PART 195816-1**
#48 Drive Chain for 1/2 HP-16' 1

- PART 195112-1**
#41 Drive Chain for 3/4 HP-12' 1
- PART 195114-1**
#41 Drive Chain for 3/4 HP-14' 1
- PART 195116-1**
#41 Drive Chain for 3/4 HP-16' 1

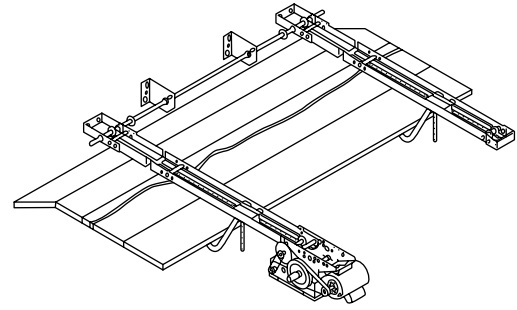

DUAL TROLLEY MODIFICATION

- For use with doors over 22' wide
- 1/2 horse power
- 12', 14', 16' and 18' High doors

PART 65520812STK
1/2 HP Dual Trolley
Modification 12' 1

PART 65520814STK
1/2 HP Dual Trolley
Modification 14' 1

PART 65520816STK
1/2 HP Dual Trolley
Modification 16' 1

PART 65520818STK
1/2 HP Dual Trolley
Modification 18' 1

- For use with doors over 22' wide
- 3/4 or greater horse power
- 12', 14', 16' and 18' High doors

PART 655208112STK
3/4 HP+ Dual Trolley
Modification 12' 1

PART 655208114STK
3/4 HP+ Dual Trolley
Modification 14' 1

PART 655208116STK
3/4 HP+ Dual Trolley
Modification 16' 1

PART 655208118STK
3/4 HP+ Dual Trolley
Modification 18' 1



COMMERCIAL ACCESSORIES

PART TLS1CARD 1
►Provides functionality to control auxiliary devices such as lights, bells and horns

PART 02103L 1
3-Button Station with Maintenance Alert
►Nema 1
►Surface Mount, Open/Close/Stop

PART CPS3 1
CPS 3 Card with CPSU Eyes
►Option Card with eyes for applications requiring two sets of photo eyes



MOUNTING BRACKET

- Heavy 1/2" thick cast iron
- For use with J, H, and GH operators

PART 089098EZ 1
Cast Iron Hood EZ Mounting Bracket



- For use with MJ and MH operators

PART 109095 1
Commercial Mounting Bracket



- For use with MGJ, GH, J and H operators

PART 1A4324 1
Hood Angle Mounting Bracket or Rolling Steel

- For use with MJ, MH, J and H operators only

PART 1012360 1
Universal Hood Angle Mounting Bracket For Rolling Steel



- Mounting posts line up with models J, H and GH operators

PART 109099 1
Commercial Mounting Bracket

FINDING WHAT'S RIGHT FOR THE JOB

IN CERTAIN SITUATIONS A REGULAR STOCK COMMERCIAL OPERATOR MAY NOT BE THE BEST OPTION.

With that in mind, LiftMaster offers a large range of options to help serve your customers' needs and provide you with multiple opportunities to increase sales.

If you have a door over 22' wide, it is recommended to install a dual-trolley assembly. The dual trolley provides equal support for wide doors and greatly minimizes risk of damage to the top section. The front idler is replaced with a sprocket that acts as the drive for the second trolley assembly connected to the main drive via a solid shaft. Dual trolley modifications are available for both trolley and hoist openers. For hoist openers, modifications must be factory installed. To learn more about modifications, watch this video or call our sales team at 833.SSC.DOOR.



COMMERCIAL MODIFICATIONS

NON-STOCK SPECIAL ORDER REPLACEMENT PARTS AVAILABLE UPON REQUEST

COMMERCIAL LIFTMASTER



COMMERCIAL RECEIVER

- Weather-resistant for outdoor mounting requirements
- Provides convenient access to gated communities, industrial facilities, and commercial sites all with a single transmitter solution
- Three channels provide expanded remote control capacity: Channel 1 - 50 remotes, Channel 2 - 20 remotes, Channel 3 - 20 remotes
- Multiple remote control options available to provide secure access from the safety and convenience of a vehicle
- Compact design fits most gate and commercial door operators
- Compatible with 811LM, 813LM, and all MAX remote controls

PART 860LM
Universal Receiver
Security+2.0® 1

- Ideal for gated communities and commercial buildings
- Security+2.0® technology
- 3 channels provide expanded remote capacity, Channel 1 - 50 remotes, Channel 2 - 20 remotes, Channel 3 - 20 remotes
- Compact design fits in most gate and commercial door operators
- Power: 12-24VDC or 12-24VAC

PART 850LM
Universal Receiver
Security+2.0® 1 3 6

- Security+® rolling code technology, and Billion code, DIP switch compatibility
- External 8" whip antenna
- 12V DC or 18-35V AC/DC, jumper selectable
- High security memory stores up to 15 Security+® remote control or keyless entry codes
- Normal security memory stores up to 31 LiftMaster remote control codes of any type

PART 312HM
Universal Coaxial Receiver
S+ (315MHz) 1

PART 412HM
Universal Coaxial Receiver,
S+ (390MHz) 1

- Operates residential garage door openers or entry ways with Model Series 60 code switch controls having red indicator lights or operates up to 4 Model Series 80 remote controls with green indicator lights
- External 8" whip antenna
- 18-35V AC/DC

PART 422LM
Universal 2 Channel Coaxial
Receiver (390MHz) 1

PART 423LM
Universal 3 Channel Coaxial
Receiver (390MHz) 1
• Can be used with 3-button door control and a commercial door opener to perform open/close/stop functions



- Security+2.0® technology provides 2X the range of standard remote controls
- Compatible with HomeLink Wireless Control System
- 1000 remote capacity to support large quantity remote control requirements
- Compatible with LiftMaster Security+2.0® remote controls and Passport remote controls

PART STAR1000
Universal Receiver
Security+2.0® 1

- Ideal for gated communities, parking lots and garages
- Universal receiver with antenna
- For gate and commercial door operators
- Rapid learn feature allows for quick programming of multiple transmitters
- User friendly programming technology makes it easy to add, block and delete
- Available in 390 MHz or 315 MHz

PART STAR450390
Star 450 Receiver (390MHz) 1

PART STAR450315
Star 450 Receiver (315MHz) 1

- For Star 450 Receiver, also can house 312HM, 412HM, 422LM, and 423LM receivers

PART 7165WT
Commercial Access
Control Receiver 1

- Plug-in jack for easy installation on LiftMaster receivers
- Power input level: 105 - 135 AC

PART 85LM
Radio Control Plug-In
Power Supply 1



KEYPADS

- Stainless steel face with metal backlit keys
- Anodized and powder coated steel outer housing that is vandal and weather resistant to IP 66
- Dual relay outputs
- 100 million combinations of codes
- Wiegand data output
- Status indicator LED's
- Universal mounting for wall, post or gooseneck stand
- Power: 12-24V AC/DC
(no jumper selection required)
- Operating Temp: -22 to 159°F

PART KPX100
KPX 100 Keypad 1

PART KPW250
LiftMaster Wireless Security 2.0®
Keypad Metal Housing 1



- Designed to work exclusively with Security+2.0®
- Enables flexible setup, 5 permanent PINs and 10 unique temporary PINs – Allows for removal of a single PIN while maintaining full access for other users
- High-impact polycarbonate front cover that stands up to the elements

PART KPW5
LiftMaster Wireless Security 2.0®
Keypad Plastic Housing 1

- Internal antenna
- 1-6 digit PIN for each user
- Rugged cast aluminum housing
- Built-in downlight
- Power: 9-volt lithium battery
- Codes: 1,000,000+ (*MegaCode format*)
- 318 MHz

PART APC00878
MDKP Exterior Wireless Keypad
(318 MHz) 1



ANTENNA

- For use with LiftMaster Commercial Operators Models MJ, MH and MT
- Provides ability to add Coaxial antenna
- Works with all F type connector receivers
- Includes: 15' coaxial cable, antenna and mounting bracket

PART EXTANT
Coaxial External
Antenna Kit 1

PART DC5166
Remote Antenna Kit 1



DOOR & GATE PHOTO CELL

- Sender and receiver units are complete in hooded metal enclosures
- Single-pole relay is thrown when an object interrupts the beam
- Nylon fiberglass reinforced enclosures
- Heaters built-in to keep frost and moisture free
- UL 325 compliant
- NEMA 4 rated for Outdoor use
- Range: 30 FT
- Power: 12 - 24V AC/DC

PART AB602828 (Pair)
Thru Beam Sensor Photocell 1

- Complies with UL325 standard
- An external entrapment protection device type B1 non-contact sensor for use with automatic gate operators
- Produces a detection signal when infrared beam is broken
- Range: Up to 60 FT
- Power: 12-24V AC/DC
- Operating Temp: -40 to 170°F
- powder coated steel hoods

PART IRB325 (Pair)
IRB-325 Infrared Photocell 1



- Retroreflective sensor with 40 ft. sensing distance with 3" reflector
- Accepts both 24 and 110VAC
- NEMA 3, 4, 5, 12 and 13
- UL 325 Compliant

PART E3K
Photocell Kit - 40'
Sensing Distance 1

- Through-beam sensor suitable for harsh environments
- Complete with sender, receiver and mounting brackets
- NEMA 6, submersible-rated
- Range: 190 FT
- Power: universal voltage 24-240V AC, 12-240V DC

PART QS30 (Pair)
Car Wash Photoelectric
Control 1



COMMERCIAL PHOTO CELLS



BRAKE SOLENOID

PART 22120
22-120 120V
Brake Solenoid 1

PART 22240
22-240 240V and 460V
Brake Solenoid 1

PART 225751
22-5751 575V
Brake Solenoid 1



TRANSFORMER

PART 2110340
115V Transformer 1



PART K2114182
115V/230V Transformer 1



PART 215230
208/240V Transformer 1



COGGED BELT

PART 164L290
Cogged Belt 4L290 - 29" 1

PART 165L304
Cogged Belt 5L304 - 30" 1



REPLACEMENT PARTS

PART 3910167
Clutch Disk 1



PART 1310024
Limit Nut 1



PART 2310041
Limit Switch 1



• Works with T33, T3311, T50, T5011, T75, T7511, MT3311 and MT5011

PART 7510174
Front Idler Assembly 1



PART 7510170
Trolley Assembly 1



PART 7510214
Straight Arm - Commercial 1

PART 1010203
Curved Arm - Commercial 1



PHOTO CELL KIT SOLD IN PAIRS

- For openings up to 30"W (indoor use only)
- Includes: emitter, receiver, floor/wall mounting brackets and interface
- For use on mechanical dual-relay operators
- 24VAC

PART CPS
Commercial Photo Cell Kit 1



- UL-325 Compliant
- For openings up to 30"W (indoor use only)
- Includes: emitter, receiver, floor/wall mounting brackets
- Compatible with logic 2, 3, 4 and 5
- 24VAC

PART CPSU
Commercial Photo Cell Kit 1



- Monitored dual sided
- Flexible housing 45' range NEMA4

PART CPSOPEN4
Commercial Photo Cell Kit 1



- Monitored photo
- Reflective eye 50' range NEMA4

PART CPSRPEN4
Commercial Photo Cell Kit 1



- For openings up to 45"W (indoor/outdoor use)
- Includes: emitter, receiver, floor/wall mounting brackets and interface
- For use on mechanical dual-relay operators
- Watertight - NEMA4
- Pre molded for 1/2" conduit
- 24VAC

PART CPSN4
Commercial Photo Cell Kit 1



- UL-325 Compliant, Logic 4 and 5
- For openings up to 45"W (indoor/outdoor use)
- Includes: emitter, receiver, floor/wall mounting brackets
- Watertight - NEMA4
- Pre molded for 1/2" conduit
- 24VAC

PART CPSUN4
Commercial Photo Cell Kit 1



COMMERCIAL LOGIC BOARD



FOR LIFTMASTER COMMERCIAL OPERATORS

PART K001D8395

Logic 5 Circuit Board Commercial 1



PART K001D8397

Logic 5-3 Phase Power Board 1



PART K001D83961

Logic 5 Single Phase Power Board 1



• 315 MHz, MT, MJ, MH
PART K001A6424
Medium Duty Logic Board with Receiver 1



• For Logic 4 commercial operators
PART K1A6837
Commercial Logic Board - L4 1



COMMERCIAL RELAY

• Triple pole double throw

PART 24246
24VAC 3PDT Relay 1

• Double pole double throw

PART 24241
24VAC DPDT Relay 1

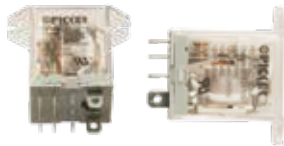

• Double pole double throw
PART 241151
115V Relay 1



• Triple pole double throw
PART 242305
230V Relay 1



ACCESSORY KIT



• Includes, CPS3, RGL24LY, TLS1CARD, 02-401M

PART FH1
Firehouse Door Operator Package 1



• Includes CPS3, RGL24LY, TLS1CARD

PART AD1
Automotive Dealer Package 1



• Includes CPS3, RGL24LY, TLS1CARD, 50-DSP7LP Loop Detector, 65-8026 – Treadle Hose, 50-14 Anchor

PART AD3
Automotive Dealer Package 1

• Includes, CPS3, RGL24LY, TLS1CARD, 02-401M, 850LM, 813LM

PART FH2
Firehouse Door Operator Package 1



• Includes CPS3, RGL24LY, TLS1CARD, 50-DSP7LP Loop Detector

PART AD2
Automotive Dealer Package 1



• IP65/ (NEMA 4) all-weather enclosure so it's ideal for indoor or outdoor use

PART RGL-CTL
Compact Red/Green Traffic Light 1



• Audible/visible warning devices
• Option board with red/green warning light box

PART RDGRNCARD
Warning Device Option Board with Red/Green Light Box 1



• Self-contained free exit system designed to detect moving vehicle and open your automatic gate.
• Connects directly to any gate operator without an external output board.
• Works with powered or solar gates.
• Cable Lead Length: 100 ft.
• Power Requirements: 8-24 VAC or 8-30 CSX
• Standby current: 30-70uA
• Alarm current: 30 to 40mA
• Enclosure rating: IP67

PART 50CP4
Vehicle Sensing Probe Single Piece 1



3/8" V BELT

PART 3L160	3/8" x 16"	1	10	25
PART 3L200	3/8" x 20"	1	10	25
PART 3L210	3/8" x 21"	1	10	25
PART 3L270	3/8" x 27"	1	10	25
PART 3L280	3/8" x 28"	1	10	25
PART 3L285	3/8" x 28 1/2"	1	10	25
PART 3L290	3/8" x 29"	1	10	25
PART 3L300	3/8" x 30"	1	10	25
PART 3L310	3/8" x 31"	1	10	25



1/2" V BELT

PART 4L190	1/2" x 19"	1	10	25
PART 4L230	1/2" x 23"	1	10	25
PART 4L240	1/2" x 24"	1	10	25
PART 4L250	1/2" x 25"	1	10	25
PART 4L260	1/2" x 26"	1	10	25
PART 4L270	1/2" x 27"	1	10	25
PART 4L280	1/2" x 28"	1	10	25
PART 4L290	1/2" x 29"	1	10	25
PART 4L300	1/2" x 30"	1	10	25
PART 4L310	1/2" x 31"	1	10	25
PART 4L320	1/2" x 32"	1	10	25
PART 4L330	1/2" x 33"	1	10	25
PART 4L340	1/2" x 34"	1	10	25
PART 4L350	1/2" x 35"	1	10	25
PART 4L390	1/2" x 39"	1	10	25
PART 4L400	1/2" x 40"	1	10	25
PART 4L450	1/2" x 45"	1	10	25



5/8" V BELT

PART 5L230	5/8" x 23"	1	10	25
PART 5L270	5/8" x 27"	1	10	25
PART 5L280	5/8" x 28"	1	10	25
PART 5L290	5/8" x 29"	1	10	25
PART 5L300	5/8" x 30"	1	10	25
PART 5L320	5/8" x 32"	1	10	25
PART 5L330	5/8" x 33"	1	10	25
PART 5L340	5/8" x 34"	1	10	25
PART 5L350	5/8" x 35"	1	10	25



SPROCKET

• Set screws included

FOR USE WITH #65 CHAIN

PART 65B10	10 Tooth, 3/4" Bore	1	
PART 65B27	27 Tooth, 3/4" Bore	1	
PART 65B30	30 Tooth, 1" Bore (1/4" Keyway)	1	

FOR USE WITH #50 CHAIN

PART 50B12	12 Tooth, 1" Bore (1/4" Keyway)	1
PART 50B18	18 Tooth, 1" Bore (1/4" Keyway)	1
PART 50B24	24 Tooth, 1" Bore (1/4" Keyway)	1
PART 50B30	30 Tooth, 1" Bore (1/4" Keyway)	1
PART 50B40	40 Tooth, 1" Bore (1/4" Keyway)	1



FOR USE WITH #41 CHAIN

PART 41B18	18 Tooth, 1" Bore (1/4" Keyway)	1
PART 41B24	24 Tooth, 1" Bore (1/4" Keyway)	1
PART 41B30	30 Tooth, 1" Bore (1/4" Keyway)	1
PART 563 (41B36)	36 Tooth, 1" Bore (1/4" Keyway)	1
PART 561 (41B36 - 1 1/4")	36 Tooth, 1 1/4" Bore (1/4" Keyway)	1





PHOTO CELL

SOLD IN PAIRS

- Use as a reversing sensor with commercial overhead doors, gates and parking barriers
- Watertight package, IP 66 rated
- Sensitivity adjustment
- Range: 30 FT
- Power: 12-240V DC and 24-240V AC
- Operating Temp: -4 to 131°F
- Includes bracket and mounting hardware
- Reflector and hood sold separately

PART NIR

Retro Reflective Photoeye 1

- Use with garage doors, rolling doors and parking barriers
- Through beam design is not affected by shiny surfaces
- Modulated infrared to reduce the effect of sunlight, fog, rain, dust and dirt
- Built in noise filter
- Power indicator LED's
- No focusing lens
- Potentiometer range adjustment allows precise tuning to site
- Range: 25 - 50 FT
- Power: 12-24V AC/DC
- Operating Temp: -40 to 170°F
- * Not for use in applications requiring UL325 compliance

PART IRB4X

Extended Range Infrared Photocell 1

- LED alignment indicator simplifies installation
- Cost-effective solution for sectional and rolling doors/gates
- Non-reflective through-beam system is not affected by shiny surfaces
- Infrared beam is not affected by sunlight, rain, dust or dirt
- Supervised relay output provides an open signal in case of power failure
- No calibration or sensitivity adjustments are necessary
- Indoor or protected operation of 30 FT
- Power: 12V - 24V AC/DC
- * Not for use in applications requiring UL325 compliance

PART PC3

Infrared Modulated Photocell 1

- Exterior, through-beam sensor with 32 ft. sensing distance
- 1P 66 Rated watertight and dust-tight
- 24-240 VAC/12-240 VDC
- Emitter, receiver and mounting brackets included
- UL Listed

PART E3JM

Kit - 32' Sensing Distance 1



- Reflective eye 50' range NEMA4

PART RPEN4RFLCTR

LiftMaster Reflector with Support Housing 1



- 3" Clear lens with white backer
- 3/16" mounting hole

PART REFLECT

3" Round Reflector 1



PART REFECTOHD

Reflector Hood 1

LiftMaster

**COMMERCIAL
LIFTMASTER**

Small Drives. Big Performance.

The VTA series is the next generation of premium commercial door operators perfect for spring balanced sectional doors.

- + Ultra quiet DC motor
- + Worm gear design provides torque for doors up to 310 SQ.FT.
- + Lightweight, powerful & easy to install
- + Built-in instant reverse
- + UL325 commercial listed
- + Integrated control board
- + Soft start/stop with variable speed
- + Battery backup optional
- + Auto detect voltage switching supports either 110V or 220V



Contact us today to learn more.
833.SSC.DOOR | servicespring.com

marantecOD

engineered for you

VTA 14-61



VTA 11-62



VTA 11-72





MARANTEC

COMMERCIAL OPERATORS

- Auto detect switching for 110v or 220v
- 897 lbs. of static holding torque
- Ultra-quiet 1/2 HP DC motor
- Built in instant reverse
- Soft start/stop with variable speed
- Rated for up to 20 cycles/hour & 450/Day
- Designed for 1" diameter solid shafts & torsion tubes
- Battery back-up compatible

PART VTA1461EHC108

Marantec VTA 14-61 Commercial DC Operator with Emergency Hand Chain & Command 108

PART VTA1461QR108

Marantec VTA 14-61 Commercial DC Operator With Quick Release & Command 108



LOOP TOOLS & ACCESSORIES

- Hard bond designed to be used only in abrasive materials like asphalt
- Do not use on concrete, blade may crack and possibly damage the machine
- 14" Dia. up to 25 horsepower

PART SBA

14" x 3/16" Asphalt Blade 1

- Soft bond and are designed to be used in hard materials such as concrete, concrete with reinforced bar, block, brick, hard pavers, clay pavers and field stones
- Using a concrete blade in abrasive surfaces like asphalt will cause the blade to wear quickly
- 14" Dia. up to 25 horsepower

PART SBC

14" x 3/16" Concrete Blade 1

- Medium bond for use in both asphalt and concrete
- Combo blades will not cut as quickly as the specialized surface blades but offer an economical solution
- 14" Dia. up to 25 horsepower

PART SBB

14" x 3/16" Combo Blade 1



- 1.35"W x 1.35"H x 0.80"D
- To be used on all of our box style detectors

PART LD11

11-Pin Socket Base Din Rail Mount 1



- 11 pin keyed female socket
- 20 AWG PVC wire
- To be used on all of our box style detectors

PART HAR11

3' Lead - 11 Pin Harness 1



- Converts AC voltage to DC
- Used with maglocks, WGEC (Horn/Strobe)
- Two yellow wires go to "24AC"
- Red wire "+DC"
- Black wire "-DC"

PART BR4

Bridge Rectifier 1



WEDGE TOOL

- Easily roll loop wire into the bottom of the saw-cut groove while standing
- Wheel is made of durable PVC that will not knick saw-cut loop jacket
- 1/8"W wheel and 135° wedge tool
- Designed for saw-cut depth up to 2/4"

PART PR316

Pizza Wheel and Wedge Tool 1



LOOP DETECTOR

- Fail safe plug-in loop detector allows the gate to stay open when vehicles are obstructing the gate path.
- Loop can be set to function as shadow loop, interrupt loop, or exit loop.
- Works with most current Liftmaster gate operators. Consult operator manual to ensure compatibility.

PART LOOPDETLM

LiftMaster Plug-in Loop Detector 1

- Reduce inventory costs by stocking only one universal voltage loop detector
- Fail Safe/Fail Secure
- Power: 9V DC to 240V AC
- Operating Temp: -40 to 180°F

PART MVPDTEK

D-TEK Loop Detector Multi Volt 1

- Ideal for vehicle detection where low power consumption is needed
- 9mA current draw makes it ideal for solar applications and gate/door operators that require many accessories drawing from the same power supply
- Power: 12-24V AC/DC
- Operating Temp: -40 to 180°F

PART LPDTEK

D-Tek Loop Detector Low Power 1

COMMERCIAL MARANTEC LOOP TOOLS & ACCESSORIES



DIRECT BURIAL LOOP

FOR USE IN CONCRETE, ASPHALT, GRAVEL OR PAVERS

18 FOOT LOOP

PART RL18-40

3' x 6' or 4' x 5' Direct Burial Loop with 40' Lead In 1

PART EL18-60

3' x 6' or 4' x 5' Direct Burial Loop with 60' Lead In 1

20 FOOT LOOP

PART RL20-40

3' x 7' or 4' x 6' Direct Burial Loop with 40' Lead In 1

PART EL20-60

3' x 7' or 4' x 6' Direct Burial Loop with 60' Lead In 1

24 FOOT LOOP

PART RL24-40

4' x 8' or 6' x 6' Direct Burial Loop with 40' Lead In 1

PART EL24-60

4' x 8' or 6' x 6' Direct Burial Loop with 60' Lead In 1

PART EL24-100

4' x 8' or 6' x 6' Direct Burial Loop with 100' Lead In 1

28 FOOT LOOP

PART EL28-60

4' x 10' or 6' x 8' Direct Burial Loop with 60' Lead In 1

PART EL28-100

4' x 10' or 6' x 8' Direct Burial Loop with 100' Lead In 1

32 FOOT LOOP

PART RL32-40

4' x 12' or 6' x 10' Direct Burial Loop with 40' Lead In 1

PART EL32-60

4' x 12' or 6' x 10' Direct Burial Loop with 60' Lead In 1

PART EL32-100

4' x 12' or 6' x 10' Direct Burial Loop with 100' Lead In 1

36 FOOT LOOP

PART RL36-40

6' x 12' Direct Burial Loop with 40' Lead In 1

PART EL36-60

6' x 12' Direct Burial Loop with 60' Lead In 1

PART EL36-100

6' x 12' Direct Burial Loop with 100' Lead In 1

40 FOOT LOOP

PART EL40-60

6' x 14' Direct Burial Loop with 60' Lead In 1

PART EL40-100

6' x 14' Direct Burial Loop with 100' Lead In 1

44 FOOT LOOP

PART EL44-40

6' x 16' Direct Burial Loop with 40' Lead In 1

PART EL44-60

6' x 16' Direct Burial Loop with 60' Lead In 1

PART EL44-100

6' x 16' Direct Burial Loop with 100' Lead In 1

52 FOOT LOOP

PART EL52-40

6' x 20' Direct Burial Loop with 40' Lead In 1

PART EL52-60

6' x 20' Direct Burial Loop with 60' Lead In 1

PART EL52-100

6' x 20' Direct Burial Loop with 100' Lead In 1



DIRECT BURIAL LOOP

EASILY INSTALLED IN NEW-POUR CONSTRUCTION

Used for installations under concrete, asphalt, pavers, or in gravel roads. The most common installation is the loop tied directly to the rebar before concrete is poured. Wire is designed for a direct burial application.

Our direct burial loops are built with solid 16AWG to create a tough rigid product that won't fall below the rebar pattern. Simply offset the loop from the rebar pattern and tie it down with the supplied cable ties.

Each direct burial loop comes with an installation kit including easy-to-follow instructions, cable ties for installation on top of rebar, ground stakes for laying out the loop in gravel and dirt roads, and stickers for easy identification after the loops have been installed.

ADDITIONAL FEATURES

- Offset the direct burial loop from the rebar pattern.
- Always run the lead-in through conduit and glue the joint with a proper PVC solvent cement.
- Run the lead-in in conduit underneath the rebar in a concrete pour.
- Remove any ground stakes before burying the loop in a gravel or dirt road.
- Fully encase the loop in sand when installing under pavers, or in a gravel road.
- Residential applications recommend a 4' short leg of the loop.
- Commercial application recommend a 6' short leg of the loop.



SCAN AWAY!

Use your **phone's camera** or download a free app to scan the QR codes to check pricing and more! See **page 1** for app suggestions.



SAW-CUT LOOP

FOR USE IN A 3/16" OR LARGER GROOVE

- Works best with 3/16" saw-cut blade or wider. (Does not work with 1/8" blade.)
- Can be used with 1/4" blade.
- Loop should be installed black side up to ensure phasing direction matches.
- Push loop in starting with the red mark opposite the yoke.
- Align loop over saw-cut groove before insertion into the groove will prevent having to pull up and realign a "tight-fitting" loop.

18 FOOT LOOP

PART SC18-20

3' x 6' or 4' x 5' Saw-Cut Loop with 20' Lead In 1

PART SC18-50

3' x 6' or 4' x 5' Saw-Cut Loop with 50' Lead In 1

20 FOOT LOOP

PART SC20-20

3' x 7' or 4' x 6' Saw-Cut Loop with 20' Lead In 1

PART SC20-50

3' x 7' or 4' x 6' Saw-Cut Loop with 50' Lead In 1

24 FOOT LOOP

PART SC24-20

4' x 8' or 6' x 6' Saw-Cut Loop with 20' Lead In 1

PART SC24-50

4' x 8' or 6' x 6' Saw-Cut Loop with 50' Lead In 1

PART SC24-100

4' x 8' or 6' x 6' Saw-Cut Loop with 100' Lead In 1

28 FOOT LOOP

PART SC28-50

4' x 10' or 6' x 8' Saw-Cut Loop with 50' Lead In 1

PART SC28-100

4' x 10' or 6' x 8' Saw-Cut Loop with 100' Lead In 1

32 FOOT LOOP

PART SC32-20

4' x 12' or 6' x 10' Saw-Cut Loop with 20' Lead In 1

PART SC32-50

4' x 12' or 6' x 10' Saw-Cut Loop with 50' Lead In 1

PART SC32-100

4' x 12' or 6' x 10' Saw-Cut Loop with 100' Lead In 1

36 FOOT LOOP

PART SC36-20

6' x 12' Saw-Cut Loop with 20' Lead In 1

PART SC36-50

6' x 12' Saw-Cut Loop with 50' Lead In 1

PART SC36-100

6' x 12' Saw-Cut Loop with 100' Lead In 1

40 FOOT LOOP

PART SC40-50

6' x 14' Saw-Cut Loop with 50' Lead In 1

PART SC40-100

6' x 12' Saw-Cut Loop with 100' Lead In 1

44 FOOT LOOP

PART SC44-20

6' x 16' Saw-Cut Loop with 20' Lead In 1

PART SC44-50

6' x 16' Saw-Cut Loop with 50' Lead In 1

PART SC44-100

6' x 16' Saw-Cut Loop with 100' Lead In 1

52 FOOT LOOP

PART SC52-20

6' x 20' Saw-Cut Loop with 20' Lead In 1

PART SC52-50

6' x 20' Saw-Cut Loop with 50' Lead In 1

PART SC52-100

6' x 20' Saw-Cut Loop with 100' Lead In 1



SEALANT

IN GRAY OR BLACK

- Apply to wet/damp substrates
- Available in Black & Gray
- 1 year shelf life
- Tube covers 20', suggested minimum 2 tubes

PART BDLSTBDS

Loop Shield 3/16" Flat Tip 30oz 1

- 12 per Case
- Apply to wet/damp substrates
- Available in Black & Gray
- 1 year shelf life
- 1 Tube covers 20', suggested minimum 2 tubes

PART BDLSBKDS

Case Loop Shield 3/16" Flat Tip 1



TOOLS AND ACCESSORIES

PART BDMEGGER

BD Loop Megohmmeter 1



- For use with BDLG2 Loop Goop

PART BDLG2GUN

BD Loop Goop Gun 1



- Winter blend

PART BDLG2

Loop Goop 600 ml Cartridges 1

We can help TEACH YOU THE ROPES

You need answers to all of your questions. Solutions Education, our free training program, was created by the experts at Service Spring to help educate the industry and provide you with standardized training. Use it anytime, anywhere.

“I am impressed. I learned a lot of valuable information from watching these videos. They are short, concise and to the point. I hope more people take advantage of this great resource.”
—David H.



servicespring.com/education | 833.SSC.DOOR



OPTICAL EDGE SYSTEM

- 16' sectional door edge kit
- Rubber door edge is durable, flexible and easy to install
- Premium rubber can be cut to exact length at the installation site
- NEMA 6 rating protects against moisture and allows edge to operate in standing water
- Infrared optical sensors eliminate the need for electrical contact
- Maximum range of 33 feet
- Meets UL 325 2010 safety standards

PART OES-SD16
Optical Edge Kit for
Sectional Doors 1



- 16' rolling door edge kit
- Rubber door edge is durable, flexible and easy to install
- Premium rubber can be cut to exact length at the installation site
- NEMA 6 rating protects against moisture and allows edge to operate in standing water
- Infrared optical sensors eliminate the need for electrical contact
- Maximum range of 33 feet
- Meets UL 325 2010 safety standards

PART OES-RD16
Optical Edge Kit for
Rolling Doors 1



SAFETY EDGE

• 1.8" x 1"
PART L504L
Monitored Large Profile Resistive
Edge with Aluminum
Channel - 4ft 1



• 1.2" x 1"
PART S504L
Monitored Small Profile Resistive
Edge with Aluminum
Channel - 4ft 1



MONITORED LIGHT CURTAIN



- Provides 36 in. of effective height coverage to increase the area of protection.
- Sets of LC-36M curtains can be mounted on a door providing coverage flexibility.
- Maximum door width of 33 ft. ensures coverage for most commercial doors.
- (8) LEDs per side and 22 cross-beams produce an invisible curtain of infrared light for maximum detection capability

PART LC36M
Light Curtain 1



PHOTO EYE

- Built-In Heater for dependable performance in most environments.
- NEMA 4X Rated for superior weather resistance.

PART LMRRUL
Monitored Photo Eyes and Reflector
With Wider Beam 1



PHOTO OPTICS



WIRELESS



SENSING EDGES

MAKING YOUR WORLD A SAFER PLACE

© Miller Edge, Inc. UL 325 Recognized Components meet or exceed requirements for monitored external entrapment devices.





SECTIONAL *directship*



ME112-C3



ME112

COMMERCIAL DOORS,
GRILLES 1 3/8" x 1 1/2"

PART ME112-C3
Plastic 1 5/16" x 1 1/4"

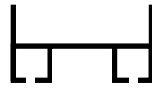

ME123-C

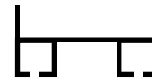

ME123-C3

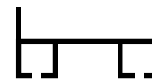

ME123-CA3

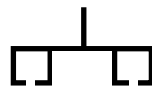

ME123-C1



ME123-C7

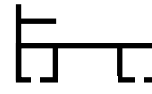

ME123-C2175

ME123

SECTIONAL DOORS, GRILLES 2" x 1 1/2"



PART ME123-C
Plastic 2"W x 1 1/4" H, U Shaped

PART ME123-C1
Plastic 2"W x 1 1/2" H, Rolling Steel

PART ME123-C3
Plastic 2"W x 1 1/4" H, L Shaped

PART ME123-C7
Plastic 3 1/2"W, Flat

PART ME123-CA3
Aluminum 2"W x 1 1/4" H, L Shape

PART ME123-C2175
Aluminum 2"W x 1 3/4" H, U Shape

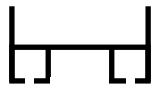

ME113-C

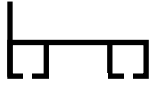

ME113-C3



ME113

COMMERCIAL DOORS 1 1/2" x 1 1/2"

PART ME113-C
Plastic 1 1/2" x 1 1/4", U shaped

PART ME113-C3
Plastic 1 1/2" x 1 1/4", L shaped



ME116

SECTIONAL DOORS 2" x 1 1/2"

►Designed to fit all CHI doors with
double track bottom retainers



MGO20

COMMERCIAL DOORS, COUNTER
SHUTTERS 1 1/2" x 2"



ME117-C7

ME117

SECTIONAL DOORS 1 29/32" x 2"

PART ME117-C7
Plastic 1 1/4" W, Flat



MU21

SECTIONAL DOORS 1 3/4" x 1"

►Mounting Tab Screws



MU22

SECTIONAL DOORS 2" x 2"

►Mounting Tab Screws



ROLLING DOOR/GATE

directship



MC22

COMMERCIAL DOORS 2" x 2"

►Slides into aluminum retainer
►Designed for Cornell rolling steel
doors with the single T groove ONLY



PRODUCT OPTION KEY

- Type:**
- Electric
 - Air Wave
 - Pneumatic
- Color:**
- Black
 - Grey
 - Yellow
 - Black/Yellow
- Wire Mount:**
- Left
 - Right
 - End
 - Universal

When placing an order for Miller Edge products please provide type, color, wire mount, monitored or non-monitored, 2 or 4 wire and the make/model of the opener. See the key for product options.



ROLLING DOOR/GATE *directship*



ME110

GRILLES, COUNTER SHUTTERS 7/8" x 3/4"

PART ME110-C
Plastic 7/8" W x 1/4" Tall

PART ME110-C3
Double Sided Tape 7/8" W x 1/4" Tall

PART ME110-C2
Plastic 7/8" x 7/8" Tall



ME111

GRILLES, COUNTER SHUTTERS 7/8" x 1 1/2"



ME120

COMMERCIAL DOORS, COUNTER SHUTTERS 1 1/2" x 2"

PART ME120-PC
PVC 1 1/16" W, Flat



MT21

ROLLING FIRE DOORS 1 3/4" x 1"

► Mounted between bottom bars



MT22

ROLLING STEEL DOORS 2" x 2"



GATE ONLY *directship*



MGR20

SWING, SLIDE, CANTILEVER ROUND POST 3 5/8" x 2 7/8"

► 3-sided activation, 3', 4', 5' long



MGS20

SWING, SLIDE, PIVOT, CANTILEVER SQUARE POST 3 5/8" x 2 7/8"

► 3-sided activation, 3', 4', 5' long

WHAT TO KNOW WHEN YOU ORDER

MODEL OF DOOR OR TYPE OF DOOR

SECTIONAL DOOR

- What is the door thickness?
- Exact width of the door panel

ROLLING STEEL

- Double Angle Bottom Bar OR Extruded Aluminum?
- Length of inside tip to tip of guide, then subtract 2"

COUNTER SHUTTER

- Double Angle Bottom Bar OR Extruded Aluminum?

DO YOU WANT WIRING FOR MOMENTARY CONTACT YES OR NO

3 QUESTIONS IF YOUR ANSWER IS YES: Is the Motor UL325, is the Edge to be the monitored device, and what is the make/model of the garage door operator?

2 QUESTIONS IF THE OPERATOR IS LIFTMASTER: Are you installing an Edge that is a new installation or replacing an existing Edge? If you are replacing, does it have a CPS-MEI or CPS-EI interface module?

THE LOCATION OF THE LEAD WIRE:

LEFT, RIGHT, END OR UNIVERSAL: Look from the inside of the garage looking out to determine the location of the lead wire.

LAST STEP, CHOOSE YOUR COLOR

BLACK, GREY, YELLOW, OR BLACK/YELLOW: not every style of Edge comes in all colors. Refer to the previous spread to learn more about which colors your products comes in.

directship

*Drop-shipped direct from the manufacturer F.O.B. Jennersville, PA 19390 or Tempe, AZ 85283



CALL US TO ORDER

This item involves assistance. Call us to place your order at **833.SSC.DOOR**

MILLER EDGE ROLLING DOOR / GATE

*Edges and channels sold separately

All Pricing Subject To Change



SENSING EDGE

- Waterproof
- Accommodates wire .181 to .312

PART JB02PW

Junction Box – NEMA4 1

- Straight connector and 90° connector
- 2 wire nuts, 11 knock outs
- 3¾"H x 1½"W x 1½"D

PART JB02

Metal Junction Box 1



- AW-14 Air Wave Switch
- 12' - 2 wire coil cord
- Plugs

directship

PART AW50018C

Air Wave Kit 18' - Coil Cord 1
▶18' of ½" air hose

PART AW50024C

Air Wave Kit 24' - Coil Cord 1
▶24' of ½" air hose



- AW-14 Air Wave Switch
- 25' - 2 wire cord reel
- Plugs

directship

PART AW50018R

Air Wave Kit 18' - Cord Reel 1
▶18' of ½" air hose

PART AW50024R

Air Wave Kit 24' - Cord Reel 1
▶24' of ½" air hose



ACCESSORIES *directship*

- Accommodates varied interface options and monitors all hardwired edges that require an input other than 10k resistive

PART GEM102

Gate Edge Module, 2-Wired Pulse 1

PART GEM103

Gate Edge Module, 4-Wired Pulse 1

PART GEM104

Gate Edge Module, Normal Close 1

- For motorized doors and automated gates
- 30 ft. Range
- Enhanced sunlight immunity
- Impact resistant for rugged environments
- UL 325, Nema 4, 2-year warranty

PART RGKR

Monitored Reflective Photo Eye with Relay Output 1



- Provide 2 outputs for compatibility with nearly all gate operator brands

PART MIM62

Muti-Input Module 1



- Includes single channel receiver and transmitter.
- Non-Monitored

PART MWRT12

Safety Edge Wireless Transmitter
1 10
50 100



- Monitors the presence and function of T2 sensing edges

PART RBGK10

RBand Monitored Wireless Gate Link Kit 1



PART RBGRX10

RBand Monitored Gate Link Receiver 1

PART RBTX10

RBand Monitored Gate Link Transmitter 1



LIGHT CURTAIN *directship*

UL APPROVED LIGHT CURTAIN THAT CAN BE USED IN PLACE OF A MONITORED PHOTO-EYE.

PART MLCK36

Light Curtain 3' 1 10

PART MLCK72

Light Curtain 6' 1 10





COIL CORD



6" TANGENT LEADS

PART CC2122

Coil Cord 12' SJE0 18 AWG 2 Wire
1 3 6

- ▶Model: 2-12-2
- ▶Retracted 2', Extended 12'

PART CC4202

Coil Cord 20' SJE0 18 AWG 2 Wire
1 3 6

- ▶Retracted 4', Extended 20'

PART CC4203

Coil Cord 20' SJE0 18 AWG 3 Wire
1 3 6

- ▶Model: 4-20-3
- ▶Retracted 4', Extended 20'

PART CC4204

Coil Cord 20' SJE0 18 AWG 4 Wire
1 3 6

- ▶Model: 4-20-4
- ▶Retracted 4', Extended 20'



ENTRY ACCESS

PART PLUG

Plug For Pneumatic or Signal Hose 1

PART ANCHOR

End Of Line Anchor for Signal Hose 1



- 3 clamps included

PART WYECON

WYE Connector For Signal Hose 1



- 4"W - 3/4"H at center point
- 10' - 2 wire lead
- 3/4" black edges with 2 1/2" safety yellow center

PART VSA3

Exterior Treadle In Protective Housing 3' 1



- .375 ID x .110 wall x 50'
- Service station grade

PART SHOSE

Signal Hose - 50' 1

- 7/16" x 5/8" x 100' roll
- Anti-Ozone additive

PART PHOSE

Pneumatic Hose -100' 1



CORD REEL



INCLUDES MOUNTING BRACKET

PART CMM2

Cord Reel 20' Metal Case 2 Wire 1

- ▶Type: SVT - 2 conductor - 18 AWG
- ▶Extended 20', without stops

PART CRM3

Cord Reel 30' Metal Case 3 Wire 1

- ▶Type: SO - 3 conductor - 18 AWG
- ▶Extended 30', without stops



PART CRP3

Cord Reel 20' Plastic Case 3 Wire 1

- ▶Type: SVT - 3 conductor - 18 AWG
- ▶Extended 20', without stops



PNEUMATIC PARTS

- Kit contains: (1) 32NOMO air switch (1) CC4202 coil cord, 14' PHOSE and (1) plug

PART PNKITA

Pneumatic Kit With Coil Cord 1



- Kit contains: (1) 32NOMO air switch (1) CMM-2 Coil Reel, 20' PHOSE and (1) Plug

PART PNKITC

Pneumatic Kit With Cord Reel 1



- Metal box
- Model: 32NOWB
- Used with Part# SHOSE signal hose only

PART 32NOWB

3 Wire Exterior Air Switch 1



- Plastic box
- Model: 32NOMO
- Used with part# PHOSE pneumatic hose only

PART 32NOMO

3 Wire Exterior Air Switch 1



PART CLAMP

Signal Hose Clamp 1

directship

*Drop-shipped direct from the manufacturer F.O.B. Jennersville, PA 19390 or Tempe, AZ 85283

PNEUMATIC COIL CORD & REEL



MOTION DETECTOR

- Detection field is 20' x 16'
- Detection fields are adjustable either manually or with remote (sold separately)

PART 50HERK2
LiftMaster
Motion Detector 1



- The Hawk 2 automatic door sensor detects vehicles and pedestrians
- Three programmable motions, toward, away or both

PART HAWK2
Industrial Motion Sensor 1



• For Falcon Sensor
PART FALCON
Programmable Remote 1



• For Hercules
PART REMOTEH
Programmable Remote 1



- 6 modes of detection
- Remote sold separately

PART FALCON1
Industrial Door, Gate
Motion Detector 1



• Extends unit 20"-36"
PART HDB
Heavy Duty Bracket
for Falcon 1



• Mounting height 6½' to 23'
• Includes 23' of cable
PART HERCULES
Motion Presence
Detector 1



• Available in Low or High mounting options
• Water Resistant
PART EAGLE
Unidirectional Tracking
Motion Detector 1



CONTROL STATION

- Momentary Contact
- 2⁷/₁₆" H x 2³/₁₆" W x 1¹³/₁₆" D
- UL Listed, NEMA 1

PART PBS1

1-Button Station

1 3 6

- Momentary Contact, Open/Close
- 4¹/₁₆" H x 2³/₁₆" W x 1¹³/₁₆" D
- UL Listed, NEMA 1

PART PBS2

2-Button Station

1 3 6

- Momentary contact, open/close/stop
- 5⁵/₁₆" H x 2³/₁₆" W x 1¹³/₁₆" D
- UL Listed, NEMA 1

PART 278

3-Button Station

1 3 6

- Flush mount, momentary contact, open/close/stop
- Stainless Steel Faceplate: 4¹/₄" H x 2³/₄" W
- Back Box: 4" x 2", NEMA 1

PART PBC3

3-Button Station

1 3 6



- Flush mount, momentary contact, open/close/stop
- Faceplate: 4¹/₂" H x 2³/₄" W
- Back Box: 4¹/₄" H x 2¹/₂" W, NEMA 1

PART LCE3

3-Button Station

1 3 6

- Exterior surface mount
- 4³/₈" H x 4¹/₈" W x 2⁵/₈" D
- NEMA 4

PART 1BX

1-Button Exterior Station

1 3 6

- Exterior surface mount, open/close
- 4³/₈" H x 4¹/₈" W x 2⁵/₈" D
- NEMA 4

PART 2BX

2-Button Exterior Station

1 3 6

- Exterior surface mount, open/close/stop
- 4³/₈" H x 4¹/₈" W x 2⁵/₈" D
- NEMA 4

PART 3BX

3-Button Exterior Station

1 3 6



- Exterior surface mount, Open/Close/Stop
- 5³/₄" H x 2³/₄" W x 2¹/₂" D
- Non-metallic enclosure, double pole contacts
- UL Listed, CSA Approved, NEMA 4

PART 3BXT

3-Button Exterior Station

1 3 6

- Exterior surface mount, open/close/stop with lockout
- 7" H x 2³/₄" W x 2³/₄" D
- UL Listed, CSA Approved, NEMA 4
- Keyed randomly or use Part# 3BXLTKA for keyed alike

PART 3BXLTKA

3-Button Exterior Station with Lockout

1 3 6

- Exterior surface mount, open/close with lockout
- 4³/₈" H x 4¹/₈" W x 2⁵/₈" D
- UL Listed, NEMA 4

PART 2BXL

2-Button Exterior Station with Lockout

1 3 6

- Exterior surface mount, open/close/stop with lockout
- 4³/₈" H x 4¹/₈" W x 2⁵/₈" D
- UL Listed, NEMA 4

PART 3BXL

3-Button Exterior Station with Lockout

1 3 6



THERE'S MORE

See more CONTROL STATIONS on the next page!

- Combine any CONTROL STATIONS for best quantity pricing

COMMERCIAL WALL STATION



CONTROL STATION

- Flush exterior mount, Open/Close/Stop
- Faceplate: 6" H x 4¾" W x 2⅞" D
- Back Box: 3¾" H x 3¾" W

PART 3BFX

3-Button Exterior Station

1 3 6

- Flush mount, Open/Close/Stop with lockout, NEMA 1
- Faceplate: 6" H x 4¾" W x 2⅞" D
- Back Box: 3¾" H x 3¾" W

PART 3BFL

3-Button Exterior Station with Lockout

1 3 6



CEILING PULL SWITCH

- Exterior surface mount
- 4" H x 3¾" W x 2¾" D
- NEMA 4

PART CP1

Exterior Ceiling Pull Switch 1

▶Single pull, single throw

PART CP2

Exterior Ceiling Pull Switch 1

▶Double pull, single throw

▶Active 2 devices

(ex. turn on heater/open door)



KEYED OUTSIDE DISCONNECT

- Disconnect operator from outside door
- Includes: mounting hardware, 3' of cable and 2 keys
- Keyed randomly or use Part# 272A for keyed alike

PART 272

Keyed Outside Disconnect

1 10
25 300



METAL KEY SWITCH

- Includes: cylinder, mounting plate, hardware and 2 keys

PART MKS1

Metal Key Switch

▶Keyed Random

PART MKS1A

Metal Key Switch

1 10 25
▶Keyed Alike



KEY SWITCH

OPEN/CLOSE WITH CENTER RETURN, UL LISTED, NEMA 4

- Tamper proof exterior surface mount

PART 1KX

Exterior Key Switch

1 3 6

- Tamper proof exterior surface mount key switch with stop button

PART 1KXS

Exterior Key Switch

1 3 6



BELL WIRE

- Built-in cable grabber wire latch

PART BW182

Bell Wire 22/2 Solid - 500' 1

▶22 AWG, 22/2 conductor

PART BW184

Bell Wire 22/4 Solid - 500' 1

▶22 AWG, 22/4 conductor



PUSH BUTTON

- For interior residential operator use
- Sturdy, durable gray plastic

PART PB1

Residential Push Button

1 25 50



INTERLOCKING SWITCH

- Interior flush door track mount with bracket
- For sectional doors
- Disables operator when door is locked
- 3" H x 3" W x 1½" D

PART IS2

Interlock Switch For Sectional Door

1



GATE OPERATORS

**RAISING
STANDARDS
ON SAFETY
& SECURITY**

LiftMaster®

servicespring.com | 833.SSC.DOOR



LA400UL RESIDENTIAL SWING GATE OPERATOR



- 24VDC residential
- Includes: (1) actuator arm, (1) standard control box, (2) 7Ah batteries, (1) LMRRUL monitored photo reflective eye
- Max gate length 16', Max gate weight 850 lbs.
- Battery backup - 400 cycles
- Standby power up to 97 days
- Fire department compliant
- 2 year warranty

RECOMMENDED ACCESSORIES:

- LA400DCS - secondary arm
- 210W - Solar kit, includes: (2) 10W-12V solar panels, battery harness
- 50CP4 - Sensing probe
- LOOPDETLM - loop detector, needs expansion board and connecting cable
- K1D8387-1CC - expansion board
- K94-34778 - connecting cable
- MG1300 - magnetic lock
- APOW3 - power supply for lock
- 811LMX, Security+2.0®, and MAX remotes
- KPW5, KPW250, and 878MAX - keypads



LA412UL RESIDENTIAL SWING GATE OPERATOR



- 12VDC solar residential
- Includes: (1) actuator arm, (1) standard control box, (2) 7Ah batteries, (1) 10W 12V solar panel, (1) LMRRUL monitored photo reflective eye
- Max gate length 16', Max gate weight 850 lbs.
- Standby power up to 126 days
- Fire department compliant
- 2 year Warranty

RECOMMENDED ACCESSORIES:

- LA412DCS - Secondary arm
- 50CP4 - sensing probe
- LOOPDETLM - loop detector, needs expansion board and connecting cable
- K1D8387-1CC - expansion board
- K94-34778 - connecting cable
- 811LMX, Security+2.0®, and MAX remotes
- KPW5, KPW250, and 878MAX - keypads



LA500UL RESIDENTIAL/COMMERCIAL SWING GATE OPERATOR



- 24VDC residential/light commercial
- Includes: (1) actuator arm, (1) standard control box, (2) 7Ah batteries, (1) LMRRUL monitored photo reflective eye
- 120/230 volt single phase
- Max gate length 18', Max gate weight 1600 lbs.
- Battery backup - 500 cycles
- Standby power up to 24 days
- Fire department compliant
- 2 year warranty

RECOMMENDED ACCESSORIES:

- LA500DCS - secondary arm
- 210W - solar kit, includes: (2) 10W-12V solar panels, battery harness
- 50CP4 - sensing probe
- LOOPDETLM - loop detector
- MG1300 - magnetic lock
- APOW3 - power supply for lock
- 811LMX, Security+2.0®, and MAX remotes
- KPW5, KPW250, and 878MAX - keypads



RSW12UL RESIDENTIAL SWING GATE OPERATOR

- 12VDC residential swing gate
- Includes: (1) swing gate pad mount operator, (1) 7Ah batteries, (1) LMRRUL monitored photo reflective eye
- Max gate length 16', max gate weight 1000 lbs.
- Standby power up to 63 days
- Fire department compliant
- 3 year warranty

- RECOMMENDED ACCESSORIES:**
- 20W7A - Solar kit includes: (1) 20W 12V solar panel, (1) 7Ah battery and wire harness
 - 20W33A - Solar Kit includes: (1) 20W 12V solar panel, (1) 33Ah battery and wire harness
 - 50CP4 - Sensing probe
 - LOOPDETLM - loop detector
 - K1D8387-1CC - expansion board
 - K94-34778 - connecting cable
 - 811LMX, Security+2.0®, and MAX remotes
 - KPW5, KPW250, and 878MAX - keypads



CSW24UL COMMERCIAL SWING GATE OPERATOR

- 24VDC high traffic swing gate
- Includes: (1) swing gate pad mount operator, (2) 7Ah batteries, (1) LMRRUL monitored photo reflective eye
- 120/230 volt single phase
- Max gate length 18', Max gate weight 1600 lbs.
- Standby power up to 24 days
- Fire department compliant
- 7 year Res., 5 year comm. warranty

- RECOMMENDED ACCESSORIES:**
- 210W - solar kit, includes: (2) 10W-12V solar panels, battery harness
 - 40W33A - solar kit includes: (2) 20W 12V solar panel, (2) 33Ah battery and wire harness
 - 50CP4 - sensing probe
 - HTR - heater
 - LOOPDETLM - loop detector
 - 811LMX, Security+2.0®, and MAX remotes
 - KPW5, KPW250, and 878MAX - keypads



CSW200UL COMMERCIAL SWING GATE OPERATOR

- AC commercial high traffic swing gate operator
- Max gate length up to 22', Max gate weight up to 2000 lbs.
- Fire department compliant
- 7 year residential, 5 year commercial warranty

- RECOMMENDED ACCESSORIES:**
- 50CP4 - sensing probe
 - LOOPDETLM - loop detector
 - HTRNB - heater
 - MG1300RLYPKG - magnetic lock
 - 811LMX, Security+2.0®, and MAX remotes
 - KPW5, KPW250, and 878MAX - keypads



RSL12UL RESIDENTIAL SLIDE GATE OPERATOR

- 12VDC residential slide gate
- Includes: (1) slide gate pad mount operator, 25' black oxide #41 chain, (1) 7Ah batteries, (1) LMRRUL monitored photo reflective eye
- Max gate length 25', Max gate weight 800 lbs.
- Standby power up to 63 days
- Fire department compliant
- 3 year warranty

- RECOMMENDED ACCESSORIES:**
- 20W7A - solar kit includes: (1) 20W 12V solar panel, (1) 7Ah battery and wire harness
 - 20W33A - solar kit includes: (1) 20W 12V solar panel, (1) 33Ah battery and wire harness
 - 50CP4 - sensing probe
 - LOOPDETLM - loop detector
 - K1D8387-1CC - expansion board
 - K94-34778 - connecting cable
 - 811LMX, Security+2.0®, and MAX remotes
 - KPW5, KPW250, and 878MAX - keypads



SL3000UL COMMERCIAL SLIDE GATE OPERATOR

- AC commercial high traffic slide gate operator
- Max gate length up to 50', max gate weight up to 2000 lbs.
- Fire department compliant
- 7 year residential, 5 year commercial warranty

- RECOMMENDED ACCESSORIES:**
- 50CP4 - sensing probe
 - LOOPDETLM - loop detector
 - HTRNB - heater
 - MG1300RLYPKG - magnetic lock
 - 811LMX, Security+2.0®, and MAX remotes
 - KPW5, KPW250, and 878MAX - keypads



CSL24UL COMMERCIAL SLIDE GATE OPERATOR

- 24VDC high traffic slide gate
- Includes: (1) slide gate pad mount operator, 30' black oxide #41 chain, (1) 7Ah batteries, (1) LMRRUL monitored photo reflective eye
- 120/230 volt single phase
- Max gate length 50', Max gate weight 1500 lbs.
- Standby power up to 24 days
- Fire department compliant
- 7 year residential, 5 year commercial warranty

- RECOMMENDED ACCESSORIES:**
- 210W - Solar Kit, includes: (2) 10W-12V solar panels, battery harness
 - 40W33A - solar kit includes: (2) 20W 12V solar panel, (2) 33Ah battery/harness
 - 50CP4 - sensing probe
 - HTR - heater
 - LOOPDETLM - loop detector
 - 811LMX, Security+2.0®, and MAX remotes
 - KPW5, KPW250, and 878MAX - keypads

**SLIDE OPERATORS
INCLUDE (1) LMRRUL
& (1) S505AL** (Special Order)

See page 105 for more information

**SWING & SLIDE
GATE OPERATORS
LIFTMASTER**

All Pricing Subject To Change



BARRIER GATE

- Barrier arms sold separately
- Built-in battery backup provides seamless operation of the gate operator and all DC control and sensing devices in the event of a power loss.

PART MADCBB3/MATDCBB3

Mega Arm/Mega Arm Tower

- The heavy-duty motor supports 6,000 cycles per day with an operator speed of 2.5 seconds to open or close.

PART MASDCBB3/MASTDCBB3

Mega Arm Sprint/Mega Arm Sprint Tower

- The heavy-duty motor supports 10,000 cycles per day with an operator speed of .9 seconds to open or close.
- Max. 8' arm

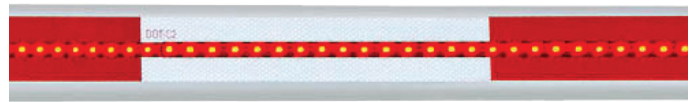

BARRIER GATE ARM

PART SP8

1

PART 50ALMARDOT

Square 15' Aluminum Arm with Retro Reflective DOT Tape 1

PART MA024RDOT

12' Aluminum Arm with Retro Reflective DOT Tape 1

PART MA024-10

10' Articulating Arm 1

PART MA034RDOT

9' White Articulating PVC 1

PART MA035RDOT

9' White PVC Arm 1

PART MA116RDOT

17' White Aluminum Arm with Retro Reflective DOT Tape 1
►Arm requires counter weight

PART MALED12

12' LED ARM (3" O.D.) for Mega Arm MA or Mat 1

PART MALED17

17' LED ARM (3" O.D.) for Mega Arm MA or Mat 1
►Requires MALEDCW ordered separately



ACCESS CONTROL

- Built-In Heater for dependable performance in most environments.
- NEMA 4X Rated for superior weather resistance.

PART LMRRUL
Monitored Photo Eyes and Reflector With Wider Beam 1



- Internet-enabled outdoor access control system – with VOIP technology
- Make updates 24/7 through an IP address (no software to install), so you never have to take IPAC off-line.
- Manage resident info from any browser on you LAN, so you do not physically visit the unit

PART CAPXL
Internet Enabled Access Control 1



- Commercial and Gated Community Telephone Entry System
- Versa XS 4.0 menu driven software
- Allow up to 2000 4 digit codes.
- Stainless Steel

PART EL2000SS
Telephone Entry System w/LCD EL2000SS 1



- Connects directly to residential home phone line
- 200 (4-digit) unique programmable entry codes

PART EL1SS
Telephone Intercom and Access Control System 1



- Functions as stand-alone controller or proximity card reader access controller

PART KPR2000
Wired Keypad and Proximity Reader 1



- Residential and commercial telephone entry system
- Versa XS 4.0 menu driven software
- Recessed, Lighted, ADA compliant keypad

PART EL25N
Residential Telephone Entry System 1



- Compatible with all standard Wiegand protocols
- Can be programmed with 1 and 3 button remote controls

PART PPWR
Passport Receiver with Security+2.0® Technology 1



PAD MOUNT PEDESTAL



- 42" pedestal, multiple hole configuration
- Pad Mount, 2" x 2" square post
- Black powder coated finish

PART PED42
Pad Mount Pedestal 42" 1



- For use with the PPWR receiver

PART PPV3M
Passport MAX 3-Button Visor Remote 1



- For use with the PPWR receiver

PART PPK3M
Passport MAX 3-Button Keychain Remote 1 24 48 100



PART PPK3PHM
Passport MAX 3-Button Keychain with Prox Remote Control 1

Over 60 years of innovation that's **uniquely better.**

Since 1962, SSC has celebrated four generations of leadership and a core commitment to quality and innovation. That's over 60 years of focus on our people, our business, and most importantly, on you, our customer.

servicespring.com | 833.SSC.DOOR





MODEL	TYPE	VOLTS	MAX LENGTH	MAX WEIGHT	GATE SPEED
PRO-SW3000 XLS	SINGLE	12 V DC	16'	650 LBS.	15-18 SEC
PRO-SW3200 XLS	SECOND ARM				

(solar charger optional)



SW3000XLS RESIDENTIAL SWING GATE OPERATOR

- For gates up to 16' long and 650 lbs.
- Includes battery back-up, 318MHz receiver, entry transmitter, AC transformer and all necessary mounting hardware for a post mount
- Easy install, no electrician or welding required
- Soft start/stop



SW3200XLS SECONDARY ARM FOR DUAL GATES

- Works as a second gate opener, includes 40' power cable



MODEL	TYPE	VOLTS	MAX LENGTH	MAX WEIGHT	GATE SPEED
PRO-SW4000 XLS	SINGLE	12 V DC	20'	1000 LBS.	18-20 SEC
PRO-SW4200 XLS	DUAL				

(solar charger optional)



SW4000XLS RESIDENTIAL SWING GATE OPERATOR

- For gates up to 20' and 1000 lbs
- Includes battery back-up, 318MHz receiver, entry transmitter, AC transformer and all necessary mounting hardware for a post mount
- Full systems capable "add on ready" heavy duty control board includes adjustable obstructions sensing, fate sequencing and auto close settings
- Soft start/stop



SW4200XLS SECONDARY ARM FOR DUAL GATES

- Works as a second gate opener, includes 40' power cable



PART RB741
One Button Remote 1



PART F3100MBC
Residential Wireless Intercom System 1



PART FM144
Automatic Gate Lock 1



PART FM139
Driveway Vehicle Exit Sensors 50' 1

PART FM140
Driveway Vehicle Exit Sensors 100' 1

PART FM141
Driveway Vehicle Exit Sensors 150' 1



- 400' range
- Indoor chime announces visitor or unwelcome guest

PART R4500
Wireless Vehicle Sensor 1



PART FM123
10-Watt Solar Panel 1



- 56 timer actions each week
- 24V AC/DC
- 24 Hour

PART 25002006
7-Day Programmable Timer 1

LINEAR™

GATE
LINEAR

107

All Pricing Subject To Change



STANDARD DUTY GATE HINGES

FOR RESIDENTIAL AND COMMERCIAL APPLICATIONS

- Sold in pairs, 1,000 lbs. per pair
- Dependable roller bearing design with even weight distribution
- Easy to fully lubricate
- Limited lifetime warranty

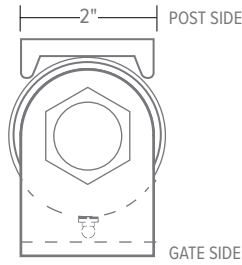

PART 2100P
Flat Mount, Both Sides
Primed 1

PART 2100U
Flat Mount, Both Sides
No Finish 1

PART 2100Z
Flat Mount, Both Sides
Zinc 1

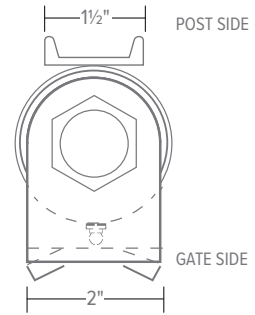

PART 2110P
Round Mount, Both Sides
Primed 1

PART 2110Z
Round Mount, Both Sides
Zinc 1

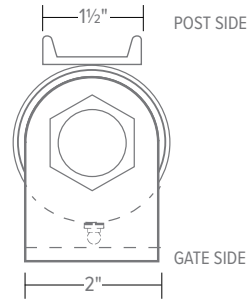

PART 2115P
Flat to Gate, Round to Post
Primed 1

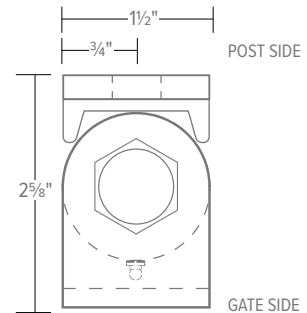
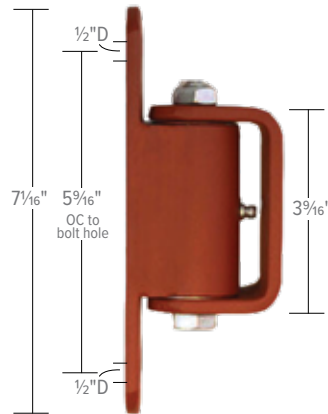

PART 2125P
Flat to Gate, Bolt to Post
Primed 1

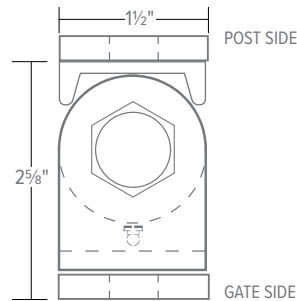
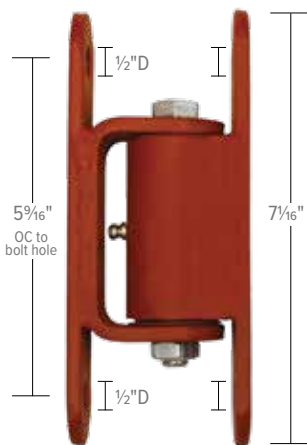

PART 2150P
Bolt to Gate, Bolt to Post
Primed 1

PART 2150Z
Bolt to Gate, Bolt to Post
Zinc 1

PART 2150B
Bolt to Gate, Bolt to Post
Black PC 1

QUALITY GATE HINGES

- Five times the weight bearing surface of the nearest large hinge
- Largest attached weld surface in the industry
- Even-weight distribution from "side to side"
- Grease fitting for cavity lubrication
- Hardened steel roller bearing system that is fully lubricated
- Weight capacities from 1,000 to 3,000 lbs. per pair

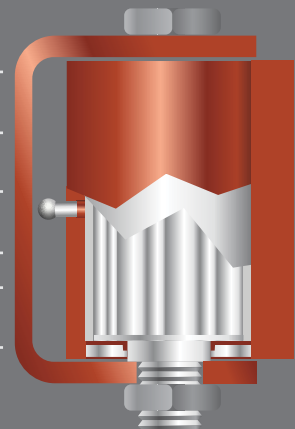

CHOOSE A MODEL
Pick the part number you need based on the mounting type.

CHOOSE A FINISH
Most parts come in different finishes. Samples are at the bottom of each spread.

CALL SERVICE SPRING
Call our friendly staff to place your order at **833.SSC.DOOR**



HEAVY DUTY GATE HINGES

FOR HEAVY AND HIGH-CYCLE GATES

- Most sold in pairs, 3,000 lbs. per pair
- Dependable roller bearing design with even weight distribution
- Easy to fully lubricate
- Limited lifetime warranty

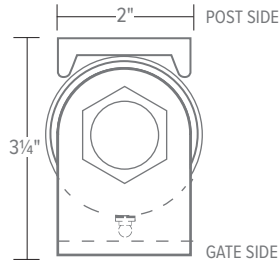

- PART 2000P**
Flat Mount, Both Sides
Primed 1
- PART 2000U**
Flat Mount, Both Sides
No Finish 1
- PART 2000Z**
Flat Mount, Both Sides
Zinc 1

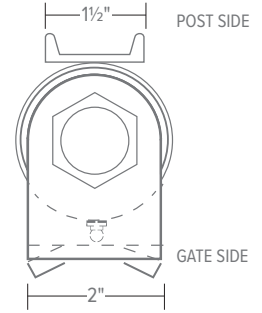

- PART 2010P**
Round Mount, Both Sides
Primed 1
- PART 2010Z**
Round Mount, Both Sides
Zinc 1

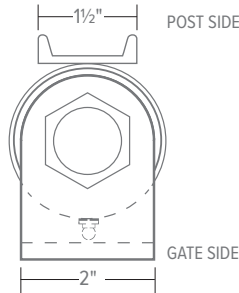

- PART 2015P**
Flat to Gate, Round to Post
Primed 1
- PART 2015Z**
Flat to Gate, Round to Post
Zinc 1

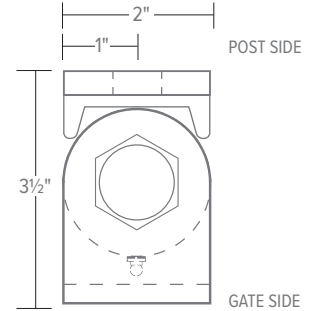

- PART 2025P**
Flat to Gate, Bolt to Post
Purchased Individually
Primed 1

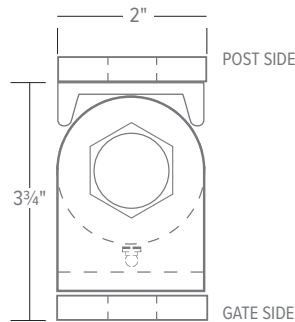
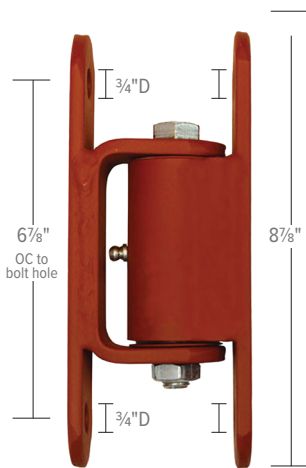

- PART 2050P**
Bolt to Gate, Bolt to Post
Purchased individually
Primed 1
- PART 2050Z**
Bolt to Gate, Bolt to Post
Purchased individually
Zinc 1



- Double 5/8" ball bearings for smooth operation
- 3/4" Solid stainless steel shaft, grounded and tempered to rockwell standards
- Continuous cycle operation, self-lubricating/no grease fittings
- Offers a unique design so the gate never hits the post
- 3,000 lbs. per pair weight capacity
- For use on steel gates with steel mounting posts

- PART POWERHINGE**
Power Hinge
Steel 1
- PART POWERHINGE2**
Power Hinge
Aluminum and Steel 1
- PART POWERHINGE3**
Power Hinge
Aluminum 1

AVAILABLE FINISHES

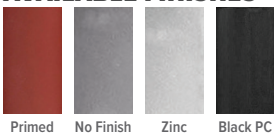

GATE HINGE HARDWARE



TAMPER-PROOF FOR HIGH-SECURITY SITES & PRIVACY



- Sold in pairs, 1,000 lbs. per pair
- Dependable roller bearing design with even weight distribution
- Limited lifetime warranty

PART 2060P
Flat Mount, Both Sides
Primed 1

PART 2060U
Flat Mount, Both Sides
No Finish 1

PART 2060Z
Flat Mount, Both Sides
Zinc 1



PART 2064P
Round to Gate, Round to Post
Primed 1

PART 2064Z
Round to Gate, Round to Post
Zinc 1



PART 2062P
Bolt to Gate, Bolt to Post
Purchased individually
Primed 1



ADJUSTABLE ADDED FLEXIBILITY OF 1/2" ADJUSTABILITY

- Sold in pairs, 1,000 lbs. per pair
- Dependable roller-bearing design with even weight distribution
- Limited lifetime warranty

PART 3100P
Flat Mount, Both Sides
Primed 1

PART 3110P
Bolt to Gate, Bolt to Post
Primed 1

PART 3100Z
Flat Mount, Both Sides
Zinc 1

PART 3150P
Bolt to Gate, Bolt to Post
Primed 1

PART 3150Z
Bolt to Gate, Bolt to Post
Zinc 1



SPECIALTY FOR USE WITH HEAVY OR HIGH-TRAFFIC GATES

- Dependable roller bearing design
- Easy to fully lubricate
- Limited Lifetime Warranty

PART 2170AS
Flat to Gate, Flat to Post
Aluminum/Stainless Steel 1

PART 2180SS
Flat Mount, Both Sides
Stainless Steel 1

PART 2185SS
Bolt to Gate, Bolt to Post
Stainless Steel 1

ADJUSTABLE GATE HINGE

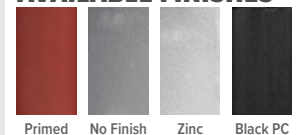
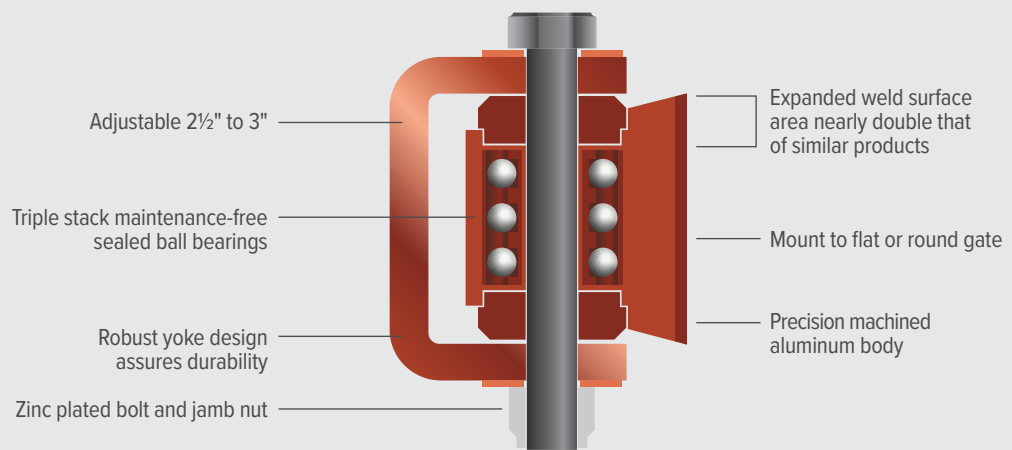



GUIDE ROLLER SHIELDED



- Commercial grade EPDM non-mar rubber
- Electroplated zinc coated steel housing
- Attractive self-contained and easy to install system
- Manufactured to meet/exceed UL325 requirements
- Add the 2241GRB bracket for a dual system

PART 22413GR
Shielded Gate Guide Roller
3" - Black 1



PART 22416GR
Shielded Gate Guide Roller
6" - Black 1



GUIDE ROLLER

PART NW6271BK
Guide Roller - Black 1

PART AUHM
Single UHMW Roller
Black 1



SINGLE GUIDE ROLLER

FOR USE WITH AUTOMATIC GATES

- Steel rollers bearings and steel reinforced roller
- Silent operation with neoprene material

PART GR123-RB
Standard Mount, 11"
Black 1

PART GR123-RG
Standard Mount, 11"
Gray 1



CANTILEVER ROLLER

PART CLCRMS312
3½" Cantilever Roller 1

PART CLCRG4022
3" or 4" Roller Cover Top 1

PART CLCRMS4
4" Cantilever Roller 1

VISIT OUR WEBSITE

EASIER THAN EVER

With additional product information, videos and 360° images, you can learn anything you want to know about a product before you order it.

If our website doesn't have an answer for you, our friendly sales team is available to help at 833.SSC.DOOR

Visit servicespring.com today.

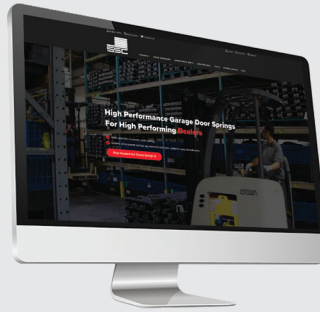

POWER WHEEL FOR USE WITH AUTOMATIC GATES AND V-TRACK

- 5/8" zinc plated bolt and nut
- Steel rollers bearings and steel reinforced roller
- Silent operation with neoprene material
- ↳Sold as pair

- 5/8" zinc plated bolt and nut
- Steel rollers bearings and steel reinforced roller
- Silent operation with neoprene material

PART HT5000V
Heat Treated Power
Wheels - 6" 1

PART AH107
Steel Power Wheels - 4" 1

PART AH110
Steel Power Wheels - 6" 1

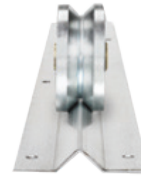

V-TRACK FOR USE WITH POWER WHEEL

PART VTRACK
10' V-Track - Unpainted 1

PART VTRACKBLK
10' V-Track - Black 1



WHEEL COVER FOR USE WITH AUTOMATIC GATES

- 5/8" zinc plated bolt and nut
- Steel rollers bearings and steel reinforced rollers

PART 22204S
Steel Wheel Cover - 4" 1

PART 22206S
Steel Wheel Cover - 6" 1

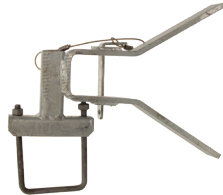
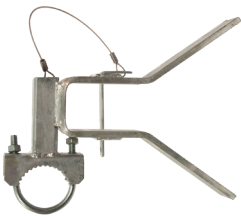

GATE RECEIVER

PART CL7233
27/8" Cantilever Gate Receiver
with Locking Gate 1

PART CL7233SQ
27/8" Square Cantilever Gate
Receiver with Locking Gate 1

PART CL7234
4" Cantilever Gate Receiver
with Locking Gate 1

PART CL7234SQ
4" Square Cantilever Gate Receiver
with Locking Gate 1



GATE LATCH

PART CL7231
27/8" Round Cantilever
Gate Latch 1

PART CL7232
4" Round Cantilever
Gate Latch 1



MOUNTING BRACKET



FOR AUTOMATIC GATES

- 5/8" zinc plated bolt and nut
- Steel rollers bearings and steel reinforced rollers

PART AH103

Gate Mounting Bracket for 4" Wheel 1

PART AH1036

Gate Mounting Bracket for 6" Wheel 1



ROLLER BRACKET



ADJUSTABLE GUIDE

PART 2241GRB
Single UHMW Roller 1

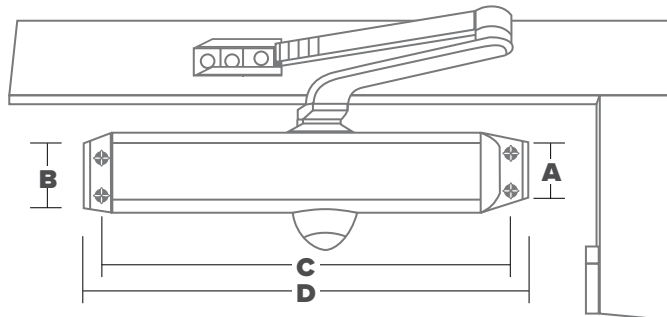
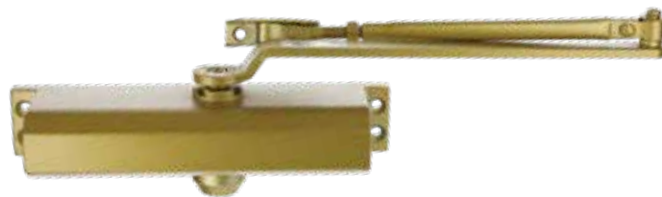

ENTRY DOOR CLOSER

PERFECT FOR ALUMINUM, GLASS AND WOOD DOORS

- Surface Mounted Interior and Exterior
- Non-Handed
- Permanent lubricating hydraulic fluid

PART #	SIZE	DIM A	DIM B	DIM C	DIM D
1870	#3	3/4"	1 3/4"	8 3/16"	8 15/16"
1872	#3	3/4"	1 3/4"	8 3/16"	8 15/16"
1874	#3	3/4"	1 3/4"	8 3/16"	8 15/16"
1868	#4	3/4"	1 3/4"	9 1/16"	9 13/16"
1869	#4	3/4"	1 3/4"	9 1/16"	9 13/16"
1873	#4	3/4"	1 3/4"	9 1/16"	9 13/16"

SIZE #3

PART 1870
Entry Door Closer
Aluminum 1

PART 1872
Entry Door Closer
Bronze 1

PART 1874
Entry Door Closer
Dark Brown 1

PART 1870BC
Entry Door Closer - Aluminum with
Back Check 1

SIZE #4

PART 1868
Entry Door Closer
Aluminum 1

PART 1869
Entry Door Closer
Bronze 1

PART 1873
Entry Door Closer
Dark Brown 1

PART 1868BC
Entry Door Closer - Aluminum with
Back Check 1



GATE LOCK

- 1300 lbs. holding force
- Stainless steel fully enclosed housing

PART EMLO1300F

Face Mounted Outdoor
Maglock 1

PART EMLO1300S

Side Mounted Outdoor
Maglock 1



PART 2520424

Magnetic Slide
Gate Lock 1

- Includes mounting hardware
- 24v DC



- Horizontal use on walk-through gates
- Great for pools, playgrounds

PART FM145

Bulldog Pedestrian
Gate Lock 1

GATE HARDWARE & ENTRY DOOR CLOSER



FIERCE GARAGE PROTECTION.

Uniflex™ Garage Door Thermostop® offers superior adhesion and minimal flex distortion. That's protection at its most intense.

32 colors: 21 standard and 11 Solar Reflective™
3 widths: Standard 2", R&R 2^{5/8"} and 3^{1/4"} Architectural

Call 833.SSC.DOOR or go to servicespring.com

 **ROYAL**[®]
Garage Door Systems

© 2023 Westlake Royal Building Products™



2149 UNIFLEX
2" STANDARD

3029 UNIFLEX
2-5/8" R&R

2591 UNIFLEX
3-1/4" ARCHITEC.

UNIFLEX 2149 / 3029 / 2591

LIFETIME NEVER ROT MATERIAL

- Select colors engineered with new solar reflective technology
- Available in 3 widths: 2" Standard
- 2 5/8" R&R
- 3 1/4" Architectural

- 75% better flex adhesion
- Patent-pending profile design creates uniform packing and reduces flex distortion
- New flexmount design accommodates both top and side mount applications

D= **directship**

LENGTH	7'	8'	9'	10'	12'	14'	16'	18'
2149 2" (15 pc/box)								
P78 - White	2149WH7	2149WH8	2149WH9	2149WH10	2149WH12	2149WH14	2149WH16	2149WH18
P408 - Sandstone	2149SS7	2149SS8	2149SS9	D	D	2149SS14	2149SS16	2149SS18
P48 Almond	2149AL7	2149AL8	2149AL9	D	D	2149AL14	2149AL16	2149AL18
P31 Brown	2149BR7	2149BR8	2149BR9	D	D	2149BR14	2149BR16	2149BR18
P645 Onyx Black*	2149BL7	D	D	D	D	2149BL14	2149BL16	2149BL18
P446 - Chocolate Brown	2149CHOB7	2149CHOB8	2149CHOB9	D	D	D	2149CHOB16	2149CHOB18
P401 - Bronze	2149TR7	2149TR8	2149TR9	D	D	D	2149TR16	D
P501 - Hunter Green	D	2149HG8	D	2149HG10	D	D	2149HG16	2149HG18
P509 - Gray	D	D	D	D	D	2149GRY14	2149GRY16	2149GRY18
P443 - Wicker	D	D	D	D	D	2149WK14	2149WK16	2149WK18
P574 - Desert Tan	2149DT7	2149DT8	D	D	D	2149DT14	2149DT16	2149DT18
P5 - Dark Brown	D	D	D	D	D	D	2149BRP16	2149BRP18
P44 - White	D	D	D	D	D	D	2149WHP4416	2149WHP4418
P477 - Claytone	—	—	D	D	D	D	2149CT16	2149CT18
3029 2 5/8" (10 pc/box)								
P78 White	D	D	D	D	D	3029WH14	3029WH16	3029WH18
P645 Black*	D	D	D	D	D	3029BL14	3029BL16	3029BL18
2591 3 1/4" (10pc/box)								
P78 White	D	D	D	D	D	2591WH14	2591WH16	2591WH18
P641 Black*	D	D	D	D	D	2591BL14	2591BL16	2591BL18

mix&match

PART NUMBERS IN-STOCK

*Uniflex in black is priced per foot. Additional costs may apply.

PRODUCT LONGER THAN 8 FEET?

Additional shipping charges may apply for products longer than 8'.

WEATHER SEAL

All Pricing Subject To Change

SEAL THE DEAL WITH SUPERIOR QUALITY FROM ADVANCED PLASTIC CORP.

Advanced Plastic Corp is the industry leader in manufacturing weatherseals and gaskets for all Commercial and Residential Overhead Doors. Our superior co-extrusion process guarantees the finest durable weatherseals available. Our superior customer service will go above your expectations by meeting just-in-time demands. Our products will add value to your overhead door.

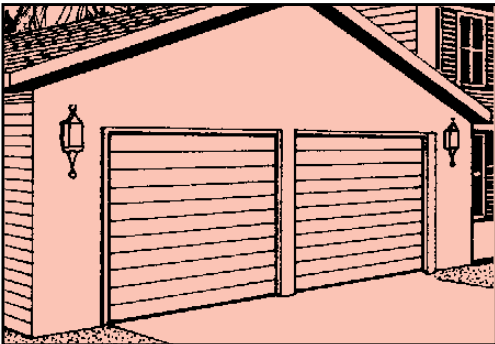

**All products available from
Service Spring Corp.**

**ADVANCED
PLASTIC CORP.**

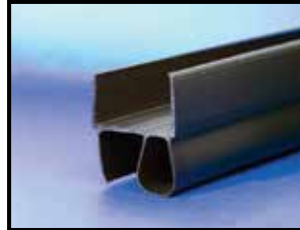

Bottom Seal

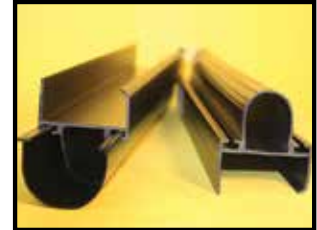

Combo Btm. Seal Retainer



Door Stop (11 Colors)

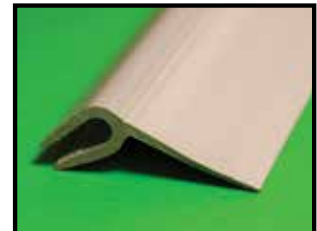

Guide Seal



Top Seal



Rolling Steel Bottom Seals



Threshold Seal



Spring Filler

**For complete information call or
visit our website...**

www.servicespring.com
1703 Tollgate Dr., Maumee, OH 43537
833.SSC.DOOR
(1.833.772.3667)



1 3/4" DOOR STOP DS-134

• 13 pieces per box

LF1 LF3 LF6

LENGTH	7'	8'	9'	10'	12'	14'	16'	18'
White (W)	•	•	•	•	•	•	•	•



Side Flap

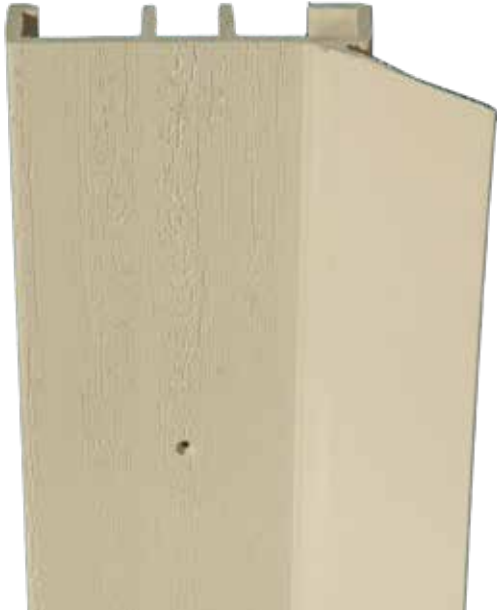

2" DOOR STOP DS-200

• 15 pieces per box

LF1 LF3 LF6

LENGTH	7'	8'	9'	10'	12'	14'	16'	18'
Almond (A)	•C	•C	•C	•C	•C	•C	•C	•C
Brown (B)	•C	•C	•C	•C	•C	•C	•C	•C
Chocolate (C)	•C	•C	•C	•C	•C	•C	•C	•C
Desert Tan (DT)	•C	•C	•C	•C	•C	•C	•C	•C
Gray (GY)	•	•	•	•	•	•	•	•
Sandstone (S)	•C	•C	•C	•C	•C	•C	•C	•C
Terratone (T)	•C	•C	•C	•C	•C	•C	•C	•C
White (W)	•C	•C	•C	•C	•C	•C	•C	•C



CONTRACTOR SERIES (C)

• 15 pieces per box

LF1 LF3 LF6

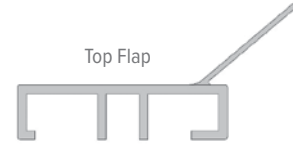

Top Flap



2 5/8" DOOR STOP DS-258

• 14 pieces per box

LF1 LF3 LF6

LENGTH	7'	8'	9'	10'	12'	14'	16'	18'
Almond (A)	•C	•C	•C	•C	•C	•C	•C	•C
Brown (B)	•C	•C	•C	•C	•C	•C	•C	•C
Chocolate (C)	•C	•C	•C	•C	•C	•C	•C	•C
Desert Tan (DT)	•C	•C	•C	•C	•C	•C	•C	•C
Gray (GY)	•	•	•	•	•	•	•	•
Green (GN)	•	•	•	•	•	•	•	•
Sandstone (S)	•C	•C	•C	•C	•C	•C	•C	•C
Terratone (T)	•	•	•	•	•	•	•	•
White (W)	•C	•C	•C	•C	•C	•C	•C	•C



CONTRACTOR SERIES (C)

• 14 pieces per box

LF1 LF3 LF6^s

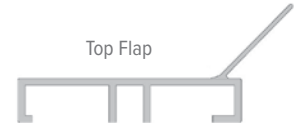

Top Flap



Pre-punched for uniform nail setting and placement assistance

directship

*All products are drop-shipped direct from the manufacturer F.O.B. Lincolnwood, IL 60712. Quantity pricing based on multiple-box purchases of same model length and color.

PRODUCT LONGER THAN 8 FEET?

Additional shipping charges may apply for products longer than 8'.

WEATHER SEAL

All Pricing Subject To Change



RING SHANK NAIL

- 14 GA galvanized steel
- Maze/Stronghold brand
- 1 $\frac{1}{16}$ " L, $\frac{3}{16}$ " head

5 LB BOXES

PART 1421

1 $\frac{1}{16}$ " Ring Shank Nail - White

PART 1422

1 $\frac{1}{16}$ " Ring Shank Nail - Brown

PART 1423

1 $\frac{1}{16}$ " Ring Shank Nail - Almond

PART 1424

1 $\frac{1}{16}$ " Ring Shank Nail - Sandstone
1 35.75 6 34.42

50 LB BOXES

PART 1425

Ring Shank Nail - White 1

PART 1426

Ring Shank Nail Sandstone 1



SMOOTH SHANK NAIL $\frac{1}{4}$ " HEAD

- Stainless steel
- $\frac{1}{4}$ " head

1 LB BOXES

PART 1427

1 $\frac{1}{4}$ " Smooth Shank Nail - White

PART 1428

1 $\frac{1}{4}$ " Smooth Shank Nail - Sandstone
1 6



- 14 GA Galvanized Steel
- Maze/Stronghold brand

5 LB BOXES

PART R113M61

1 $\frac{1}{2}$ " Smooth Shank Nail - White

PART R113M22

1 $\frac{1}{2}$ " Smooth Shank Nail - Brown

PART R113M190

1 $\frac{1}{2}$ " Smooth Shank Nail - Almond

PART R113M300

1 $\frac{1}{2}$ " Smooth Shank Nail - Black

PART R113M97

1 $\frac{1}{2}$ " Smooth Shank Nail - Sandstone
1 23.00 6 22.15

50 LB BOXES

PART R113050061WH

1 $\frac{1}{2}$ " Smooth Shank Nail - White 1



2" ROLLED DOOR STOP 150' RDS-200

- Easily installs on straight, gothic and arched openings
- Reduce storage space and inventory
- Can ship via UPS
- 5" nail spacing recommended
- Install with air nail gun or stainless steel nails
- Colors: almond, black, brown, chocolate, desert tan, green, gray, sandstone, terratone, white

PART RDS2WT

2" Rolled Door Stop - White

PART RDS2ST

2" Rolled Door Stop - Sandstone
1 3 6



2 $\frac{5}{8}$ " ROLLED DOOR STOP 150' RDS-258

- Colors: Almond, Brown, Chocolate, Desert Tan, Green, Gray, Sandstone, Terratone, White

PART RDS258WT

2 $\frac{5}{8}$ " Rolled Door Stop - White

PART RDS258ST

2 $\frac{5}{8}$ " Rolled Door Stop - Sandstone
1 3 6



WOOD DOOR BOTTOM SEAL

- (2) 100' per box
- Soft foam style

PART 520

1 $\frac{3}{8}$ " Bottom Seal
1 4

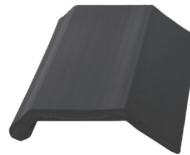

- 100' per box
- Hard rubber

directship

PART WDA138

1 $\frac{3}{8}$ " Bottom Seal WDA 138-100'
1 3 6

PART WDA175

1 $\frac{3}{4}$ " Bottom Seal WDA 175-100'
1 3 6



NAIL ASTRAGAL

PART 521

Astragal Nails (5 lb. box)
1 4

PART 522

Astragal Nails (50 lb. box)
1 4



ADHESIVE

PART 597

3.7 oz Threshold Glue
1 5 10



- Use one cartridge for every 17'

PART THGLUE

10.2 oz Threshold Glue
1 5 10



CLIP ON JAMB SEAL

JS-02

- Packaged (2) 100' rolls per box
- Easy installation, just slips over angle

PART JS02A

200' Clip on Jamb Seal - Almond

PART JS02S

200' Clip on Jamb Seal - Sandstone
1 3 6

PART 378

200' Clip on Jamb Seal - Black

PART 869

200' Clip on Jamb Seal - Brown

PART 367

200' Clip on Jamb Seal - Gray

PART 366

200' Clip on Jamb Seal - White
1 3 6



REVERSE SEAL

- Packaged (2) 150' rolls per box
- Must be nailed/screwed in place

PART RS175A

300' Reverse Jamb Seal - Almond

PART RS175S

300' Reverse Jamb Seal - Sandstone

PART RS175BK

300' Reverse Jamb Seal - Black

PART RS175BR

300' Reverse Jamb Seal - Brown

PART RS175W

300' Reverse Jamb Seal - White
1 3 6



SINGLE T BOTTOM SEAL



- T width: 5/16"
- Colors: black

PART 523

3 3/4" Single T Bottom Seal (250'/box)

1 3 6

PART 524

4 3/4" Single T Bottom Seal (175'/box)

1 3 6

PART 526

6" Single T Bottom Seal (200'/box)

1 3 6



BOTTOM BEAD SEAL



- 3/16" bead
- Colors: black

PART FRB300

3" Bead Astragal Bottom Seal (500'/box)

1 3 6

PART FRB400

4" Bead Astragal Bottom Seal (400'/box)

1 3 6

PART FRB600

6" Bead Astragal Bottom Seal (300'/box)

1 3 6

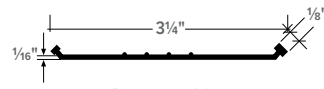
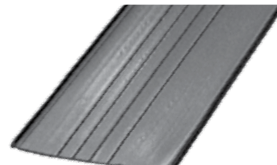

3 1/4" RESIDENTIAL ASTRAGAL WD-325



- (2) 200' rolls/box

PART WD325

3 1/4" Residential Astragal (400'/box)

1 3 6



4" BOTTOM SEAL CLO-400



- 125' per box
- Fits Clopay "O" Seal retainer only

PART CLO400

125' Black

1 3 6



UNIVERSAL RETAINER



5/16" SLOTS

directship

1 3/8" UR-138 25 pieces per box

1 LF 3 LF 6

PART UR1388 8'

PART UR1389 9'

PART UR13816 16'

1 3/8" UR-138 IN-STOCK

1 LF 3 LF 6

PART UR1388STK 8'

PART UR1389STK 9'

PART UR13816STK 16'

1 3/4" UR-175 20 pieces per box

LF 1 LF 3 LF 6

PART UR1758 8'

PART UR1759 9'

PART UR17516 16'

1 3/4" UR-175 IN-STOCK

LF 1 LF 3 LF 6

PART UR1758STK 8'

PART UR1759STK 9'

PART UR17516STK 16'

2" UR-200 15 pieces per box

PART UR200162 16'-2"

LF 1 LF 3 LF 6



ASTRAGAL RETAINER



5/16" SLOTS

directship

1 3/8" URF-138 30 pieces per box

LF 1 LF 3 LF 6

PART URF1388 8' PART URF13812 12'

PART URF1389 9' PART URF13816 16'

PART URF13810 10' PART URF13818 18'

1 1/2" URF-150

LF 1 LF 3 LF 6

PART URF1508 8' PART URF15012 12'

PART URF1509 9' PART URF15016 16'

PART URF15010 10' PART URF15018 18'

1 3/4" URF-175

LF 1 LF 3 LF 6

PART URF1758 8' PART URF17512 12'

PART URF1759 9' PART URF17516 16'

PART URF17510 10' PART URF17518 18'

2" URF-200 25 pieces per box

PART URF200162 16'-2"

LF 1 LF 3 LF 6



GARAGE DOOR THRESHOLD

- Includes 3.7 oz. adhesive tube and instructions
- Blocks/repels wind-driven rain, snow, dirt and sand
- Eliminates costly concrete repairs
- Colors: black. Gray available by special order

PART 599

Threshold 100' (10 adhesive tubes)

1 5 10

PART 595

Threshold Kit 10' (1 adhesive tube)

1 5 10

PART 596

Threshold Kit 16' (2 adhesive tubes)

1 5 10

PART 601

Threshold Kit 18' (2 adhesive tubes)

1 5 10

PART TH300K20

Threshold Kit 20' (2 adhesive tubes)

1 5 10

50



directship

*Drop-shipped direct from the manufacturer F.O.B. Lincolnwood, IL 60712. Quantity pricing based on multiple-box purchases of same model length and color.

WEATHER SEAL

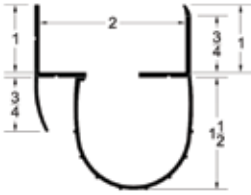

UNI-100 UNIVERSAL

IN-STOCK

- 15 pieces per box
- Eliminates the need to stock various sizes
- Fits 1 3/8" - 2" thick doors
- Available in 8'-2", 10'-2", 12'-2", 14'-2", 16'-2" & 18'-2"

LF 1 LF 3 LF 6

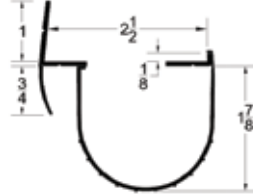

UNI-300 UNIVERSAL

- 15 pieces per box
- Open face
- Fits up to 3" thick doors
- Available in 16'-2" & 18'-2"

LF 1 LF 3 LF 6

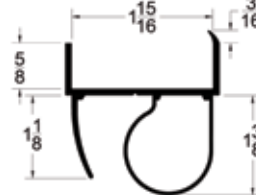

2" CP-10

- 8 pieces per box
- Available in 8', 8'-2", 9', 9'-2", 10', 10'-2", 12', 12'-2", 14', 14'-2", 16', 16'-2", 18', & 18'-2"

LF 1 LF 3 LF 6

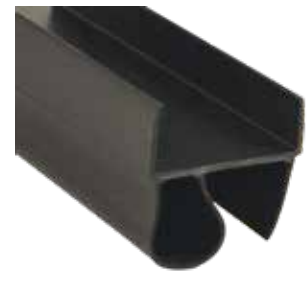

1 5/8" CP-158

- 12 pieces per box
- Available in 8', 8'-2", 9', 9'-2", 10', 10'-2", 12', 12'-2", 14', 14'-2", 16', 16'-2", 18', & 18'-2"

LF 1 LF 3 LF 6

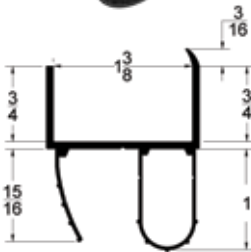

1 3/8" CP-05

- 12 pieces per box
- Available in 8', 8'-2", 9', 9'-2", 10', 10'-2", 12', 12'-2", 14', 14'-2", 16', 16'-2", 18', & 18'-2"

IN-STOCK

- Available in 8'-2", 9'-2", 16'-2", & 18'-2"

LF 1 LF 3 LF 6

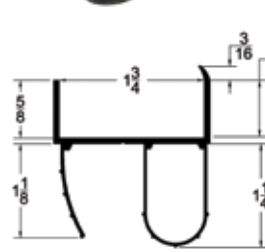

1 3/4" CP-06

- 12 pieces per box
- Available in 8', 8'-2", 9', 9'-2", 10', 10'-2", 12', 12'-2", 14', 14'-2", 16', 16'-2", 18', & 18'-2"

CONTRACTOR

- Available in 8', 9', 10', 12', 14', & 16'

LF 1 LF 3 LF 6

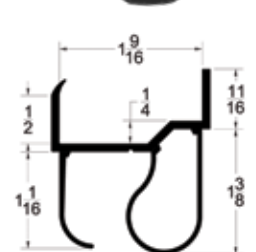

1 1/2" CP-150

- 12 pieces per box
- Available in 8', 8'-2", 9', 9'-2", 10', 10'-2", 12', 12'-2", 14', 14'-2", 16', 16'-2", 18', & 18'-2"

LF 1 LF 3 LF 6

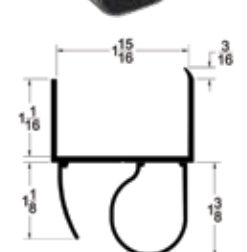

2" CP-07 LONG LEG

- 6 pieces per box
- Available in 8', 8'-2", 9', 9'-2", 10', 10'-2", 12', 12'-2", 14', 14'-2", 16', 16'-2", 18', & 18'-2"

IN-STOCK

- Available in 14'-2", 16'-2"

LF 1 LF 3 LF 6

CONTRACTOR

- Available in 8', 8'-2", 9', 9'-2", 10', 10'-2", 12', 12'-2", 14', 16', & 16'-2"

LF 1 LF 3 LF 6

WEATHER SEAL

PLEASE NOTE: Pricing is per linear foot (LF)

PRODUCT LONGER THAN 8 FEET?

Additional shipping charges may apply for products longer than 8'.

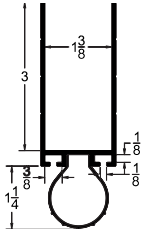

1 3/8" ARL-138

- 6 pieces per box
- Available in 8'-2", 10'-2", 16'-2", & 18'-2"

LF 1 LF 3 LF 6

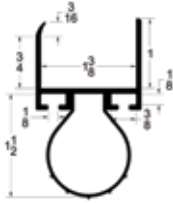

1 3/8" AR-138 ASTRAGAL

- 8 pieces per box
- Available in 8', 8'-2", 9', 10', 10'-2", 16', 16'-2", 18', & 18'-2"

LF 1 LF 3 LF 6

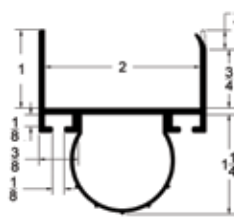

2" AR-02 ASTRAGAL

- 6 pieces per box
- Available in 8', 8'-2", 9', 9'-2", 10', 10'-2", 12', 12'-2", 14', 14'-2", 16', 16'-2", 18', & 18'-2"

IN-STOCK

- Available in 8'-2", 9'-2", 16'-2", & 18'-2"

LF 1 LF 3 LF 6

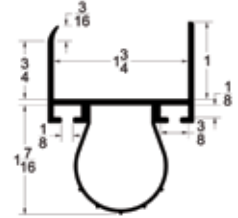
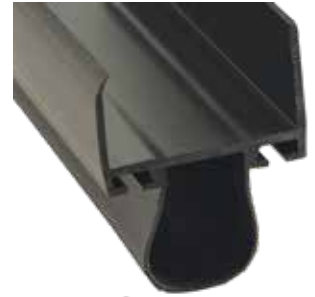

1 3/4" AR-175 ASTRAGAL

- 8 pieces per box
- Available in 8', 8'-2", 10', 10'-2", 16', 16'-2", 18', & 18'-2"

LF 1 LF 3 LF 6

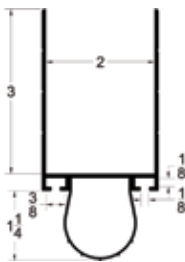

2" ARL-200

- 4 pieces per box
- Available in 8'-2", 10'-2", 16'-2", & 18'-2"

LF 1 LF 3 LF 6



1 3/8" CP-138OFB OPEN FACE

- 15 pieces per box
- Available in 8', 8'-2", 9', 9'-2", 10', 10'-2", 12', 12'-2", 14', 14'-2", 16', 16'-2", 18', & 18'-2"

LF 1 LF 3 LF 6

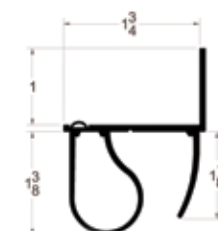

1 3/4" CP-134OFB OPEN FACE

- 12 pieces per box
- Available in 8', 8'-2", 9', 9'-2", 10', 10'-2", 12', 12'-2", 14', 14'-2", 16', 16'-2", 18', & 18'-2"

IN-STOCK

- Available in 8'-2", 10'-2", 12'-2", 16'-2", & 18'-2"

LF 1 LF 3 LF 6

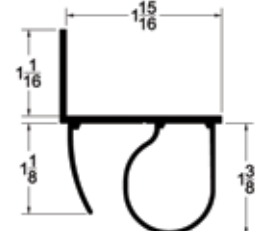

2" CP-070FB OPEN FACE

- 10 pieces per box
- Available in 8'-2", 9'-2", 10'-2", 12'-2", 14'-2", 16'-2", & 18'-2"

LF 1 LF 3 LF 6



WEATHER SEAL

*Unless otherwise noted, all products are drop-shipped direct from the manufacturer F.O.B. Lincolnwood, IL 60712. Quantity pricing based on multiple-box purchases of same model length and color.

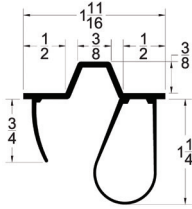
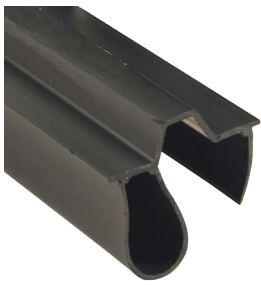

2" TG-200
TONGUE & GROOVE

- 15 pieces per box
 - Available in 8', 8'-2", 9', 9'-2", 10', 10'-2", 12', 12'-2", 14', 14'-2", 16', 16'-2", 18', & 18'-2"
- LF 1 LF 3 LF 6

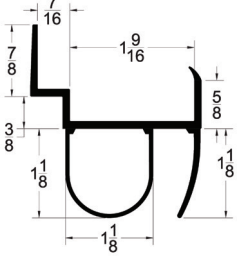
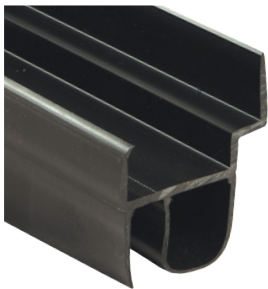

2" SL-08
SHI LAP

- 6 pieces per box
 - Available in 8', 8'-2", 9', 9'-2", 10', 10'-2", 12', 12'-2", 14', 14'-2", 16', & 16'-2"
- LF 1 LF 3 LF 6

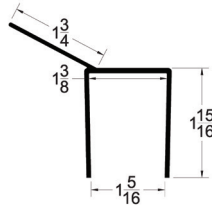
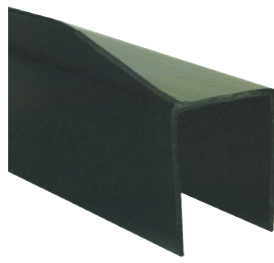

1 3/8" TC-138
TOP CAP

- 12 pieces per box
 - Available in 8', 9', 10', 12', 14', 16', & 18'
- LF 1 LF 3 LF 6

1 5/8" TC-158

- 12 pieces per box
 - Available in 8'-2", 9'-2", 10'-2", 12'-2", 14'-2", 16'-2", & 18'-2"
- LF 1 LF 3 LF 6

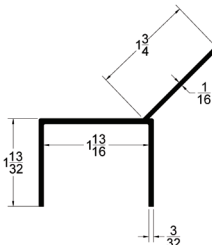

1 3/4" TC-175

- 12 pieces per box
 - Available in 8'-2", 9'-2", 10'-2", 12'-2", 14'-2", 16'-2", & 18'-2"
- LF 1 LF 3 LF 6

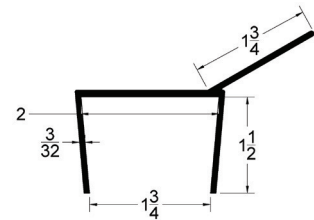

2" TC-200

- 8 pieces per box
 - Available in 8', 9', 10', 12', 14', 16', & 18'
- LF 1 LF 3 LF 6



TS-200
TOP SEAL

- Packaged (2) 150' roll per box
- 2" flap

PART TS200 300'
1 3 6

TS-300
TOP SEAL

- Packaged (1) 100' roll per box
- 3" flap

PART TS300 100'
1 3 6



TS-15
TOP SEAL SINGLE FLAP

- Packaged (2) 100' rolls per box
- Applied with tek screws or rivets
- 1 1/4" flap

PART 368 200'
1 3 6



TS-14
TOP SEAL DOUBLE FLAP

- 15 pieces per box
- First flap 1 1/2"
- Second flap 2"
- Available in 8', 8'-2", 9', 9'-2", 10', 10'-2", 12', 12'-2", 14', 14'-2", 16', 16'-2", & 18'-2"
- Packaged (2) 150' rolls per box

PART TS14 300'
LF 1 LF 3 LF 6



GS-20
GUIDE SEAL - GRAY

- 25 pieces per box
- Fits 3/16" - 1/4" angle

PART GS2086 8'-6"
PART GS2096 9'-6"
PART GS20106 10'-6"
PART GS20126 12'-6"
PART GS20146 14'-6"
PART GS20166 16'-6"
LF 1 \$ LF 3 \$ LF 6 \$



GS-38
GUIDE SEAL - GRAY

- 20 pieces per box
- Fits 1/4" - 3/8" angle

PART GS3886 8'-6"
1 3 6



RB-21F
ROLLING STEEL DOOR
VINYL - BLACK

- Packaged (2) 75' rolls per box
- For use with double angle bottom bars
- Optional gray and yellow colors available

PART 479 150'
1 3 6

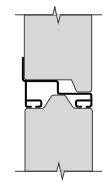
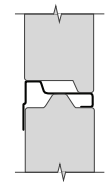

ADAPTER RAIL
ALUMINUM

PART A201501W82
Shi Lap/Tongue and Groove
1 40

PART A201502W82
Tongue and Groove/Bottom Retainer
10 40

PART A201501W164
Shi Lap/Tongue and Groove
10 20

PART A201502W164
Tongue and Groove/Bottom Retainer
10 20

WEATHER SEAL

PLEASE NOTE: Pricing is per linear foot (LF)
*10-piece minimum to ship aluminum adapter rails and retainer.

PRODUCT LONGER THAN 8 FEET?

Additional shipping charges may apply for products longer than 8'.



HEADER SEAL

ROLLING STEEL
HEADER - GRAY

- 75' per box
- Width: 6.25"

PART HS625 75'
1 3 6



HS-22S HEADER SEAL - GRAY

• 6 pieces per box

PART HS22S8 8'
PART HS22S11 11'
PART HS22S13 13'
PART HS22S15 15'
LF 1 LF 3 LF 6

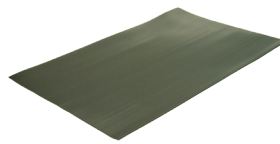

BAFFLE

ROLLING STEEL HOOD
BAFFLE - BLACK



PART HB8 150' x 8"
1 3 6
PART HB10 150' x 10"
1 3 6
PART HB12 150' x 12"
1 3 6



SNP001

SNAP-ON MINI
WAREHOUSE - GRAY



• 20 pieces per box
PART SNP0014 4'
PART SNP0019 9'
LF 1 LF 3 LF 6



ALUMINUM RETAINER



PART A131501W82
1 3/8" x 1 1/2" x 8'2" L Shaped
Aluminum Retainer 10
PART A131501W164
1 3/8" x 1 1/2" x 16'4" L Shaped
Aluminum Retainer 10

PART A201001W82
2" x 1" x 8'2" L Shaped
Aluminum Retainer 10
PART A201001W164
2" x 1" x 16'4" L Shaped
Aluminum Retainer 10

PART A181801W82
1 3/4" x 1 3/4" x 8'2" L Shaped
Aluminum Retainer 10
PART A181801W164
1 3/4" x 1 3/4" x 16'4" L Shaped
Aluminum Retainer 10

PART A202001W82
2" x 2" x 8'2" L Shaped
Aluminum Retainer 10
PART A202001W164
2" x 2" x 16'4" L Shaped
Aluminum Retainer 10

ADVANCED
PLASTIC CORP.

directship

*Unless otherwise noted, all products are drop-shipped direct from the manufacturer F.O.B. Lincolnwood, IL 60712. Quantity pricing based on multiple box purchases of same model length and color.

WEATHER SEAL & ALUMINUM RETAINER

*10-piece minimum to ship aluminum adapter rails and retainer.

All Pricing Subject To Change

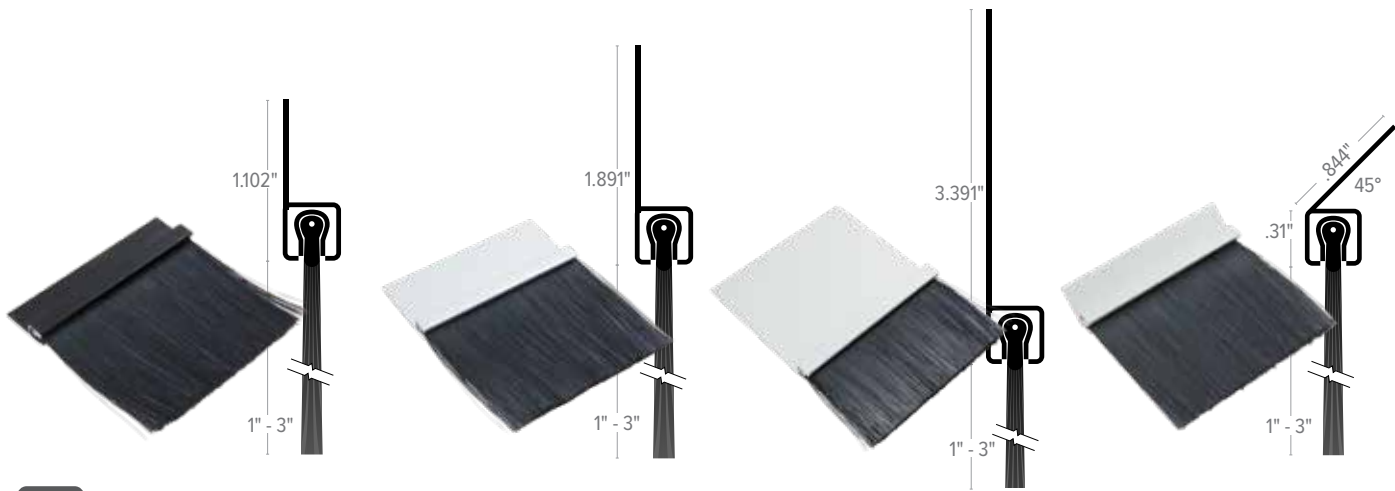

STANDARD DUTY NYLON WITH HOLDER

STRAIGHT FLANGE ANGLE BRONZE HOLDER

- PART D480DUR09BL**
1/8" Holder 1" Brush
- PART D480DUR12BL**
1/8" Holder 1 1/4" Brush
- PART D480DUR16BL**
1/8" Holder 1 1/2" Brush
- PART D480DUR20BL**
1/8" Holder 2" Brush
- PART D480DUR30BL**
1/8" Holder 3" Brush

STRAIGHT FLANGE ANGLE ALUMINUM

- PART D482CLA09BL**
2" Holder 1" Brush
- PART D482CLA12BL**
2" Holder 1 1/4" Brush
- PART D482CLA16BL**
2" Holder 1 1/2" Brush
- PART D482CLA20BL**
2" Holder 2" Brush
- PART D482CLA30BL**
2" Holder 3" Brush

STRAIGHT FLANGE ANGLE ALUMINUM

- PART D483CLA09BL**
3" Holder 1" Brush
- PART D483CLA12BL**
3" Holder 1 1/4" Brush
- PART D483CLA16BL**
3" Holder 1 1/2" Brush
- PART D483CLA20BL**
3" Holder 2" Brush
- PART D483CLA30BL**
3" Holder 3" Brush

45° FLANGE ANGLE ALUMINUM

- PART D445CLA09BL**
7/8" Holder 1" Brush
- PART D445CLA12BL**
7/8" Holder 1 1/4" Brush
- PART D445CLA16BL**
7/8" Holder 1 1/2" Brush
- PART D445CLA20BL**
7/8" Holder 2" Brush
- PART D445CLA30BL**
7/8" Holder 3" Brush

ALUMINUM HOLDER

- PART D480CLA09BL**
1/8" Holder 1" Brush
- PART D480CLA12BL**
1/8" Holder 1 1/4" Brush
- PART D480CLA16BL**
1/8" Holder 1 1/2" Brush
- PART D480CLA20BL**
1/8" Holder 2" Brush
- PART D480CLA30BL**
1/8" Holder 3" Brush

COMPARE BRUSH SEAL

STANDARD DUTY "D" SERIES is synonymous with quality, energy savings and value.

HEAVY DUTY "G" SERIES brushes, seal out the elements around large rolling steel, sectional, large service and aircraft hanger doors.

PROSEAL is a low cost polypropylene brush alternative to the nylon Therm-L-Brush.



SEALEZE BRUSH SEAL & ENTRY DOOR KITS

45° HOLDER WITH 10' BRUSH KIT PROSEAL POLYPROPYLENE

- PART C345CLA20BP120KIT**
1 1/4" Holder 2" Brush 1
- PART C345CLA30BP120KIT**
1 1/4" Holder 3" Brush 1

STANDARD DUTY STRAIGHT HOLDER WITH 10' BRUSH KIT

- PART D445CLA30BL120KIT**
7/8" Holder 3" Brush 1
- PART D483CLA30BL120KIT**
3" Holder 3" Brush 1

ENTRY DOOR JAMB KIT WITH ANODIZED HOLDER

- PART J140CLA04BL17STK**
3' x 7' Door 1
- PART J140CLA04BL18STK**
4' x 7' Door 1

ENTRY DOOR JAMB KIT WITH DARK BRONZE ANODIZED HOLDER

- PART J140DUR04BL17STK**
3' x 7' Door 1
- PART J140DUR04BL18STK**
4' x 7' Door 1

BRUSH SEAL KITS SHIPPING UPS

\$50 Minimum order

10' brush seal kits are able to ship UPS. Each kit will include (1) 6' and (1) 4' retainer and seal for a splice-free application.



CALL US TO ORDER

This item involves assistance. Call us to place your order at **833.SSC.DOOR**.

PRODUCT LONGER THAN 8 FEET?

Additional shipping charges may apply for products longer than 8'.

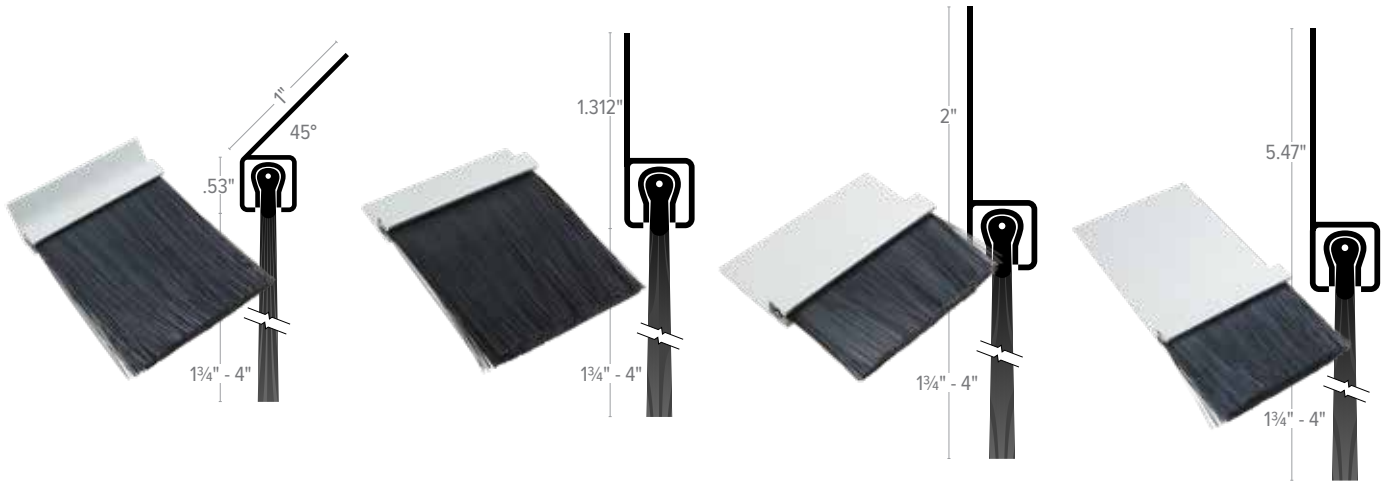

HEAVY DUTY NYLON WITH HOLDER

45° FLANGE ANGLE ALUMINUM

- PART G645CLA18BL**
1 1/8" Holder 1 3/4" Brush
- PART G645CLA25BL**
1 1/8" Holder 2 1/2" Brush
- PART G645CLA30BL**
1 1/8" Holder 3" Brush
- PART G645CLA40BL**
1 1/8" Holder 4" Brush

STRAIGHT FLANGE ANGLE ALUMINUM

- PART G680CLA18BL**
1 3/8" Holder 1 3/4" Brush
- PART G680CLA25BL**
1 3/8" Holder 2 1/2" Brush
- PART G680CLA30BL**
1 3/8" Holder 3" Brush
- PART G680CLA40BL**
1 3/8" Holder 4" Brush

- PART G682CLA18BL**
2" Holder 1 3/4" Brush
- PART G682CLA25BL**
2" Holder 2 1/2" Brush
- PART G682CLA30BL**
2" Holder 3" Brush
- PART G682CLA40BL**
2" Holder 4" Brush

- PART G685CLA18BL**
5 1/2" Holder 1 3/4" Brush
- PART G685CLA25BL**
5 1/2" Holder 2 1/2" Brush
- PART G685CLA30BL**
5 1/2" Holder 3" Brush
- PART G685CLA40BL**
5 1/2" Holder 4" Brush

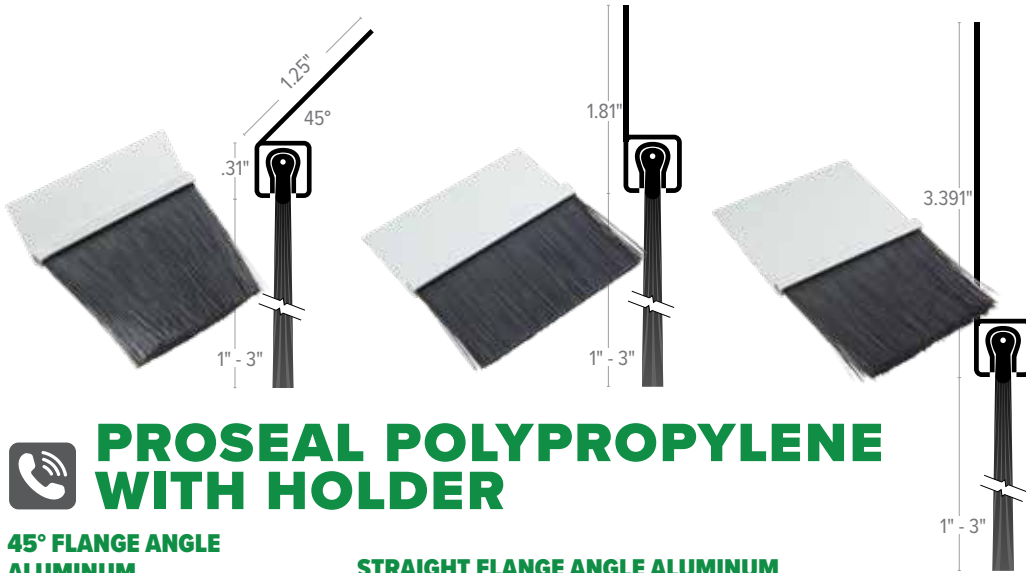

PROSEAL POLYPROPYLENE WITH HOLDER

45° FLANGE ANGLE ALUMINUM

- PART C345CLA10BP**
1 1/4" Holder 1" Brush
- PART C345CLA15BP**
1 1/4" Holder 1 1/2" Brush
- PART C345CLA20BP**
1 1/4" Holder 2" Brush
- PART C345CLA30BP**
1 1/4" Holder 3" Brush

STRAIGHT FLANGE ANGLE ALUMINUM

- PART C382CLA10BP**
1 1/2" Holder 1" Brush
- PART C382CLA15BP**
1 1/2" Holder 1 1/2" Brush
- PART C382CLA20BP**
1 1/2" Holder 2" Brush
- PART C382CLA30BP**
1 1/2" Holder 3" Brush

- PART C383CLA10BP**
3" Holder 1" Brush
- PART C383CLA15BP**
3" Holder 1 1/2" Brush
- PART C383CLA20BP**
3" Holder 2" Brush
- PART C383CLA30BP**
3" Holder 3" Brush



EZ FLEX FLEXIBLE BRUSH SEAL

- 100 foot roll
- Compatible with D series holders only
- PART FXD109BL** .94"
- PART FXD116BL** 1.61"
- PART FXD120BL** 2"
- PART FXD130BL** 3"



*All products are drop-shipped direct from the manufacturer Richmond, IN 47374, USA Ships UPS or LTL Class 70

**Max Length to Ship UPS 96" & LTL 120"

BRUSH SEAL

\$50 Minimum order

All Pricing Subject To Change



MULTI-PURPOSE SPRAY LUBE



- Sold 12 cans per case
- All weather, white lube lithium penetrating grease
- Liquefied lubricant penetrates like an oil and quickly sets up to a thick, white protective grease
- Helps prevent rust and corrosion
- Withstands temperatures (-60° to +350°F)
- Long lasting resistance to water, acids, oxidation, dirt and salt spray

PART 434*
Multi-Purpose Spray Lube - 14 Oz.

PART 560129
California Compliant
Spray Lube - 14 Oz.

1	4
10	36

PRIVATE LABEL

- No artwork setup charge
- 10 case minimum order required
- Build customer loyalty with low-cost promotion and advertising

PART 434C*
Multi-Purpose Spray Lube - 14 Oz.

PART 560129C
California-Compliant
Spray Lube - 14 Oz.

1	18
36	54

* Not for sale in California
* Unable to air freight aerosol cans



ULTRA GEL SPRAY LUBE



- Sold 12 cans per case
- Teflon® based lubricant
- Withstands extreme pressure
- High adhesive strength
- Withstands temperatures -30° to +600°F
- Prevents rust and corrosion

PART 449
Ultra Gel Spray Lube - 13 oz.

1	4	18
---	---	----

PRIVATE LABEL

- 18 case minimum order required
- Paper label
- No setup charge for single or two color artwork
- \$50 setup charge for four color artwork (one-time charge, Part #449ART)
- Custom color cap available \$1.63 per case - Part#449CAP
- Build customer loyalty, promote growth and extend your product line
- Low-cost promotion and advertising
- See form on pg 155 for ordering

PART 449C
Ultra Gel Private Label Lube - 13 oz.

1	36
---	----



Z-45 PENETRATING SPRAY LUBE



- Sold 12 cans per case
- Blended with micron-sized PTFE for long-lasting lubrication
- Works in temperatures -55°F to 475°F
- Passes 60+ days ASTM D-1748 humidity cabinet test
- Penetrates and defends against corrosion, dissolves grease and grime
- See form on pg 156 for ordering

PART 492845*
Z-45 Penetrating Spray Lube - 15 oz.

1	4	10
---	---	----

PRIVATE LABEL

- 20-Case minimum
- PART 492845C***
Z-45 Private Label Penetrating Spray Lube - 15 oz.
- | | |
|----|-------|
| 20 | 57.22 |
|----|-------|

* Not for sale in California
* Unable to air freight aerosol cans



SSC123 GARAGE DOOR LUBE

- Sold 12 cans per case
- All-purpose garage door lubricant
- Adjustable nozzle with 3-spray setting from mist to stream.
- Prevents build-up of rust & corrosion on springs, coils, bearings, rollers, etc.

PART SSC123
Adjustable-Nozzle Garage Door Lubricant - 13 Oz.

1	4
10	36



SSCAYD

- Sold 12 cans per case
- Water-resistant lubricant that penetrates tight areas
- Sets up into a grease-like gel
- Dries clear, virtually invisible

PART SSCAYD
1st Aid Gel Lube - 13 oz.

1	4
10	18



SILICONE SPRAY LUBE

- Sold 12 cans per case
- Temperature range works from -58°F to 600°F
- Retards rust and corrosion
- Odorless and colorless - non-staining
- Eliminates squeaks and quiets moving parts

PART 464
Silicone Spray Lube - 9.75 oz.

1	4	10
---	---	----

PRIVATE LABEL LUBRICANTS

BUILD CUSTOMER LOYALTY WITH LOW-COST BRAND PROMOTION

Try our private label lubricants as an easy way to include your logo on products you sell. See pages 152-154 for the fillable quote forms or fill out online with the QR code on the right.



MULTI-PURPOSE SPRAY LUBE QUOTE FORM



Z-45 PENETRATING SPRAY LUBE QUOTE FORM



ULTRA GEL SPRAY LUBE QUOTE FORM



LUBRICANTS



SCAN AWAY!

Use your phone's camera or download a free app to scan the QR codes to check pricing and more! See page 1 for app suggestions.



PRO 21 SPRAY GREASE

- Sold 12 cans per case
- Concentrated, does not contain solvents
- Permanently eliminates squeaks and rattles
- Prevents rust and corrosion

PART 436

Pro 21 Spray Grease - 9 oz.

1 4 10



PRO SL SPRAY GREASE

- Sold 12 cans per case
- Synthetic aerosolized penetrant and rust inhibitor
- Use on springs, rollers, hinges and locks
- Contains no CFC/HCFC compounds
- Withstands temperatures -65° to +300°F
- Formerly known as Tribolube

PART PROSL

Pro SL Spray Grease - 9 oz.

1 4 10



FOAMY SPRAY LUBE

- Sold 12 cans per case
- Penetrates corrosion and loosens frozen parts
- Long-lasting protection
- Resists temperature breakdown
- Extreme pressure, creeping formula

PART 463

Foamy Spray Lube - 15.75 oz.

1 4 10



SLIP IT SPRAY LUBE

- 12 cans per case
- Non-toxic FDA and USDA approved
- Paraffin-based with silicone

PART SLIPIT

SLIP IT Spray Lube - 11 oz.

1 5



GETSOME

- Sold 12 cans per case
- VOC-compliant, no odor
- Food-grade H-1NSF certified
- Sold by case

PART GS11A

Getsome GS1000 Spray Lube - 11 oz.

1 4 10



LUBRIPLATE

- For screw drive and chain drive garage door operators
- Low temperature, remains pliable down to -70°F
- ASTM dropping point of over 350°, NLGI No. 1 consistency
- Neutral lithium-based lubricant

PART 439

Aero Lubriplate Grease - 1.75 oz.

1 36 72



LOW-TEMP

- Quiets noisy doors and operators
- Excellent cold-operating characteristics
- Pumpability at -60°F to an ASTM
- Dropping point of 280°F
- Workable range from -60° F to 250°F
- Anhydrous Calcium, NLGI 11/2 grade lubricant

PART 440

Low-Temp Lubriplate Grease - 10 oz.

1 36 72



CHAIN & CABLE FLUID

- Superior penetrating oil
- A cleansing non-gumming oil
- Lubricates wire rope, chains, cables, any moving metal surfaces
- Prevents rust and corrosion

PART 135063

Chain and Cable Fluid - 11 oz.

1 5



DRILL, IMPACT & DRIVER TOOLS

- Drilling mode 3-mode: rotary hammer, hammer only, rotation only
- Thin wall core bit capacity 2 1/2"
- Solid bit capacity 1 inch
- Blow energy 2.1 Ft-lbs

PART S271322
M18 Fuel 1" SDS Plus D-Handle
Rotary Hammer Drill Kit 1

- REDLINK PLUS™ intelligence prevents damage to the tool and battery due to overloading or overheating
- LED light to illuminate the work area
- 4 custom performance profiles

PART S286320
M18 Fuel™ With One-Key™ High
Torque Impact Wrench 1

- Includes: (1) sub-compact band saw (tool only) (2429-20) blade, (1) carrying case, (1) M12™ lithium-ion battery charger (48-59-2401), (1) M12™ xc high capacity REDLITHIUM™ battery (48-11-2402), (1) 18 TPI sub-compact band saw blade

PART S299722
M18 Fuel 2-Tool Hammer Drill
Impact Driver Combo Kit 1

- Includes: (1) M18 FUEL™ 1/2" drill driver (tool only) (2803-20), (2) M18™ REDLITHIUM™ XC5.0 extended capacity battery pack (48-11-1850), (1) M18™ & M12™ multi-voltage charger (48-59-1812), (1) carrying case, (1) side handle, (1) belt clip, (1) bit holder

PART S280322
M18 Fuel 1/2" Drill
Driver Kit 1



GRINDER

- Includes: (1) m18 FUEL™ 4 1/2"-5" braking grinder (tool only) (2783-20), (1) flange nut, (1) FIXTEC nut, (1) t27 guard

PART S278322
M18 Fuel 4 1/2"-5" Braking
Grinder 1

PART S278020
M18 Fuel 4 1/2"-5" Braking Grinder
(tool only) 1

POWER SAWS & KITS

- Cuts 3/4" EMT in 3 seconds, up to 150 cuts per charge with the XC battery
- 1 5/8" cut capacity: For a wide range of applications

PART S242921XC
M12 Cordless Sub-Compact
Bandsaw Kit 1

- Includes: (1) M18 REDLITHIUM™ HIGH OUTPUT™ HD12.0 battery pack (48-11-1812), (1) M18™ & M12™ rapid charger (48-59-1808), (1) blade, (1) blade wrench, (1) contractor bag

PART S273221HD
7 1/4" Circular Saw Kit 1

- Includes: (1) M18 FUEL™ 1/2" hammer drill/driver (tool only) (2704-20), (1) M18™ & M12™ multi-voltage charger (48-59-1812), (1) m18™ REDLITHIUM™ XC5.0 Extended capacity battery pack (48-11-1850)

PART S272022
M18 Fuel Sawzall 2
Battery Kit 1



JOBSITE TOOLS

PART S289020
M18 Jobsite Radio 1

PART S279220
M18 Jobsite Radio/Charger 1

PART S088620
M18 Jobsite Fan 1

• Tool Only
PART S272421HD
M18 Fuel™ Blower 1



BATTERIES & CHARGERS

PART S48111880
M18™ Redlithium™ High Demand™
9.0 Battery Pack 1

PART S48591808
M18™ & M12™ Rapid Charger 1

PART S48591810
M18 & M12 Vehicle Charger 1





PART S48221910
Sliding Utility Knife 1



PART S48220012
Compact Hack Saw 1



PART S48220325
25' Magnetic Tape Measure 1



PART S48225107
Compact Billet Torpedo Level 1

MISCELLANEOUS TOOLS



- One or two batteries for extended run-time
- 9,000 lumens of TRUEVIEW™ HD output
- High impact polycarbonate lens

PART S215120
M18 Radius Site Light 1



- 135° rotating head
- IP54 rated: water and dust resistant
- 5 year tool warranty
- Limited Lifetime LED warranty

PART S273520
M18 LED Worklight 1



- Includes: (1) auto voltage/continuity tester with resistance (2213-20), (1) belt clip, (1) test lead set, (2) batteries

PART S221320
Auto Voltage/Continuity Tester With Resistance 1



PART SMLBX24
24" Box Level 1

PART SMLBX36
36" Box Level 1

PART SMLBX48
48" Box Level 1



PART S48228712
Large Free-Flex Work Gloves



PART S48228722
Large Performance Work Gloves

PART S48228713
Extra-Large Free-Flex Work Gloves 1

PART S48228723
Extra-Large Performance Work Gloves 1



PART S48899203
Step Kit #3 1/4" - 3/4" 1



PART S48899204
Step Kit #4 3/16" - 7/8" 1



PART S48899257
Shockwave™ Impact Duty™ Electrician Kit #1, #4, #9 Step Drill Bits 1



PART S48324062
Shockwave™ Impact Driver Bit Set - 74Pc 1



PART 48891561
Drill And Drive Set - 95 Pc 1



PART S48222507
7 Pc Magnetic Hollowcore™ Sae Nut Driver Set 1





TOOL ORGANIZERS

PART S48228425
Packout™ Large Tool Box 1

PART S48228426
Packout™ Rolling Tool Box 1



PART S48228310
10" Packout™ Tote 1



PART S48228320
20" Packout™ Tote 1



PART S48228431
Packout™ Low-Profile Organizer 1



PART S48228436
Packout™ Compact Low-Profile Organizer 1



PART S48228435
Packout™ Compact Organizer 1



BATTERIES



• Camelion
PART CR2016
3V Lithium Battery 1
►1 Per Card
►Replaces: DL2016, 5000LC, E-CR2016

• Camelion
PART CR2032
3V Lithium Battery 1
►1 Per Card
►Replaces: DL2032, 5004LC, E-CR2032

PART CR2015
3V Lithium Battery 1
►5 Per Card
►Replaces: DL2016, 5000LC, E-CR2016

PART CR2035
3V Lithium Battery 1
►5 Per Card
►Replaces: DL2032, 5004LC, E-CR2032



• Premium
PART A23BP1
12V High Voltage Battery 1
►1 Per Card
►Replaces: LR23A, LRV08, GP23A, MN21



• Premium
PART A23BP5
12V High Voltage Battery 1
►5 Per Card



PART 6LF22S
9V Alkaline Battery 1
►1 Per Card



PART 6LF22P
9V Alkaline Battery 1
►6 Per Pack



• 6F22-9V
• Energy Plus
PART 6F221B
9V Super Heavy-Duty Battery 1
►1 Per Card



• Energy Plus
PART 6F226B
9V Super Heavy-Duty Battery 1
►6 Per Pack



RATE BOOK

- Make spring conversions and cycle life upgrades
- Includes IPPT's and maximum turns
- Covers 1 1/2" - 7 7/8" ID springs



PART 365
Torsion Spring Rate Book Manual
1 \$32.80 5 \$29.40

PART 349
Pocket Torsion Spring Rate Book Manual
1 \$17.68 5 \$15.92

In 1958, SSC founder, Clarence Veigel created the first calculations for engineering garage door springs, still used today. Purchase the original hard copy book or download the SSC Spring Engineering app.



SPRING WIRE GAUGE

- Accurate spring wire measurements
- Handles .125 - .625 wire sizes
- Eliminates guess work
- A must for every truck and shop

PART 425
Spring Wire Gauge
1 5



POCKET WIRE GAUGE

- Determines wire size in one easy step
- No counting coils or fighting tape measures
- Saves time and money

PART 427
Residential Pocket Wire Gauge
1 3

•For wire sizes .1875 through .3125

PART 446
Commercial Pocket Wire Gauge
1 3

•For wire sizes .3195 through .500



TOWELS

- Heavy-duty waterless hand cleaner for removing grease, tar and oil
- 4.5 lbs original formula
- Fragrance free
- Not compatible with crème dispenser (1204-01)

PART GOJO111506
Waterless Hand Cleaner 1



PART 807GOJO
GOJO Scrubbing Towels
1 6

- 72 Count canister
- Formulated to lift heavy dirt and grime from skin
- Conditions skin and formulated to help prevent dryness and irritation



PART 481104
Multi-Purpose Cleaning Towels
1 6

- 70 towels per bucket
- Cuts through the toughest soils, grease, grime, oil, and tar
- Abrasive and smooth sides can be used to clean any surface
- Unmatched skin conditioners moisturize hands during cleaning



BEARING BLASTER

PART SSCBLASTER
Bearing Blaster
1 4 10

mix&match

- Combine **POCKET WIRE GAUGES** to achieve your best quantity pricing

mix&match

- Combine any **SPRING REPAIR BLOCKS** to achieve your best quantity pricing

TOOLS

131

All Pricing Subject To Change



WINDING BAR

SOLD IN PAIRS

PART WB1218
1/2" x 18" Winding Bar
1 4

PART 586
1/2" To 7/16" Hex Winding Bars - 18"
1 5

PART 587
5/8" To 1/2" Hex Winding Bars - 24"
1 5

PART 588
5/8" To 1/2" Hex Winding Bars - 36"
1 5

PART 575
1/2" To 7/16" Machined Winding Bar - 18"
1 5

PART 576
5/8" To 1/2" Machined Winding Bar - 24"
1 5

PART 577
5/8" To 1/2" Machined Winding Bar - 36"
1 5

PART 579
3/4" To 5/8" Machined Winding Bar - 36"
1 5



DONKEY CONE

- Use for low headroom, damaged winding cones, and wind loaded door applications
- Converts a standard 4 hole (90°) cone to 8 winding holes (45°)
- Fits 1 3/4" and 2" universal winding cones & standard winding bars
- Includes Allan wrench

PART DNKYCONE
Donkey Cone 1



LEARN MORE

Scan this code to watch a video and learn how to properly WEIGH A GARAGE DOOR.



COUNTER BALANCE LEVER ARM

- Release spring tension, multiply scale reading times five to determine door weight
- Works with ordinary bathroom scale

PART 431
Counter Balance Lever Arm 1 5



CABLE CUTTER

- Cuts up to 3/16" cable

PART 415
Felco C-7 Cable Cutter
1 5



- Cuts up to 1/4" cable

PART 414
WRC-13 Cable Cutter
1 5



MEASURING TOOL

• 12' and 25' tapes
PART 17502 (set)
2-Piece Combo Tape Measures 1

• Range 6" - accuracy +/- .008"
• Easy-To-Read LCD Display
PART 74101175
Poly-Cal Electronic Caliper 1



SPRING SPREADER TOOL

- Tool spreads and holds spring coils apart
- Drive tool in and twist, tool locks in place
- Works much better than a screwdriver

PART 465
Spring Spreader Tool
1 4



DOOR STACKER

- Designed for new construction without floor
- Easy installation and removal
- Hold door above unfinished floor
- Mount brackets to jamb at desired floor level

PART 820
Pair Door Stackers 1



CABLE SWAGER

- Multi-Compression Bench Swager
- Swages 1/16", 3/32", 1/8", 5/32" and 3/16" sleeves and stops
- Supplied with "Go No Go" gauge
- 22 1/2" long, American made

- 3/32", 1/8" and 3/16"
- High-quality 4140 carbon steel for a long life
- Adjustable and includes "Go No Go" gauge

PART 3346R
Cable Swager 1

PART 429
#1-BSC Bench Swager
1 4

- Multi-compression hand swager with cable cutter
- Swages 1/16", 3/32", 1/8", 5/32" and 3/16" sleeves and stops
- Cuts up to 7/32" diameter aircraft cable
- Easy adjustment, supplied with "Go No Go" gauge
- 26" long, American made

PART 428
#1-SC Hand Swager
1 4



SWAGER KIT

- Includes: #1-SC swaging tool and C-7 cable cutter, a sturdy metal carrying case, aluminum sleeves and stops: 1/16", 3/32", 1/8", 5/32" and 3/16", aluminum thimbles: 1/16", 3/32-1/8", 5/32" and 3/16"

PART 432
Cableware Assembly Kit 1



CABLE HOIST

DOUBLE LOCKING AND DRIVING PAWS

- Mini-Mule Model: MM 112DD
- Pull: 12 FT

- Mini-Mule Model: MM 212DD
- Pull: 6 FT

PART 841
1 Ton Heavy-Duty Double Drive Cable Hoist
1 4

PART 842
2 Ton Heavy-Duty Double Drive Cable Hoist
1 4



- Mini-Mule Model: PM 5010
- Folding handle
- Pull: 10 FT

PART 843
1/2 Ton Portable Cable Hoist with Case
1 4



CABLE PULLER

- Mini-Mule Model: MP 189
- For 1/16" to 1/4" diameter wire
- 1,300 lb capacity

- Klein Tools model: 1613-30
- Grips cable sizes from 0.08" to 0.20"
- Single V-Groove jaw - 1,500 lb capacity

PART 437
Cable Grip
1 4

PART 435
Cable Puller 1



ROLLER CHAIN

- Holder for ANSI chain sizes 35 through 60
- Allows for easy replacement of broken links
- Holds chain together in position, leaving hands free for working
- Repair roller chain without removal

PART 420
Roller Chain Holder 1



- Removes link from pin on chain sizes 25-60
- Forged steel jaws
- Press out tip made of tool steel
- Replacement tip included
- American made

PART 422
Roller Chain Breaker 1



LEARN MORE

Scan this code to learn how to use SPRING REPAIR BLOCKS in this short video!



IRWIN
VISE-GRIP TOOL

- Jaw adjustment range up to 1 1/2"
- Locks instantly and releases quickly
- Curved jaw puts tremendous pressure on four points
- Hardened teeth are designed to grip from any angle

PART 0502L3
10" Curved Jaw Vise-Grip® with Wire Cutter 1



ANGLE CUTTER

- 12 gauge steel cutting capacity
- Cuts up to 2" x 2" angle
- Heat-treated steel cutting blades

PART 162100
HD Pro Angle Cutter 1

PART 162100BL
HD Pro Angle Cutter Upper and Lower Blade Set 1



MULTI-CUT TOOL
COMES WITH 3 BLADES

PART CUT401
Ronan Large Multi Cut Tool 1

PART CUT40178
3 Replacement Blades 1



IMPACT TOOL

1/4" MALE HEX DRIVE EXTENSION

PART EX2502 2"L 1

PART EX2504 4"L 1

PART EX2506 6"L 1



1/4" x 3/8" ADAPTER

PART EX3702 2"L 1

PART EX3704 4"L 1

PART EX3706 6"L 1



1/4" HEX DRIVE MAGNETIC BIT HOLDER

PART M4902 2"L 1

PART M4904 4"L 1

PART M4906 6"L 1



1/4" HEX INSERT BIT PHILLIPS HEAD, 1" L

PART 4401SFX
#1 Point 1

PART 4402SFX
#2 Point 1



1/4" x 1/2" ADAPTER

PART EX5003 3"L 1



1/4" HEX DRIVE MAGNETIC NUT DRIVER - 6 POINT, 2" L

PART M6N08082 1/4" 1

PART M6N08122 3/8" 1

PART M6N08142 7/16" 1

PART M6N08162 1/2" 1



1/4" SQUARE DRIVE MAGNETIC SOCKET - 6 POINT 7/8" L & 1" L

PART M1P10 5/16" 1

PART M1P12 3/8" 1

PART M1P14 7/16" 1

PART M1P16 1/2" 1



3/8" SQUARE DRIVE SOCKET - 6 POINT, 1/4" L & 1/2" L

PART 3112 3/8" 1

PART 3114 7/16" 1

PART 3116 1/2" 1

PART SW605 9/16" 1

PART J7212S
8 Point 3/8" 1

PART J7214S
8 Point 7/16" 1



3/8" SQUARE DRIVE MAGNETIC SOCKET

PART M3110 5/16" 1

PART M3112 3/8" 1

PART M3114 7/16" 1

PART M3116 1/2" 1

PART M3118 9/16" 1



3/8" SQUARE DRIVE THIN WALL - 6 POINT, 1 1/2" L

PART 3412 3/8" 1

PART 3414 7/16" 1

PART 3416 1/2" 1

PART 3418 9/16" 1



3/8" SQUARE DRIVE DEEP WELL SOCKET - 6 POINT, 2" L

PART 3214 7/16" 1

PART 3216 1/2" 1

PART 3218 9/16" 1



1/2" SQUARE DRIVE MAGNETIC SOCKET - 6 POINT, 1/2" L

PART M5114 7/16" 1



HIGH SPEED STEEL DRILL BIT

PART HDG1812	1/8" Dia	1 5/8" Flute	2 3/4" L	12 pcs.	1
PART HDG31612	3/16" Dia	2 5/16" Flute	3 1/2" L	12 pcs.	1
PART HDG1412	1/4" Dia	2 3/4" Flute	4" L	12 pcs.	1
PART HDG9326	9/32" Dia	2 15/16" Flute	4 1/4" L	12 pcs.	1
PART HDG5166	5/16" Dia	3 3/16" Flute	4 1/2" L	12 pcs.	1
PART HDG386	3/8" Dia	3 5/8" Flute	5" L	6 pcs.	1



COBALT DRILL BIT

PART CJG1812	1/8" Dia	1 5/8" Flute	2 3/4" L	12 pcs.	1
PART CJG31612	3/16" Dia	2 5/16" Flute	3 1/2" L	12 pcs.	1
PART CJG1412	1/4" Dia	2 3/4" Flute	4" L	12 pcs.	1
PART CJG9326	9/32" Dia	2 15/16" Flute	4 1/4" L	12 pcs.	1
PART CJG5166	5/16" Dia	3 3/16" Flute	4 1/2" L	12 pcs.	1
PART CJG386	3/8" Dia	3 5/8" Flute	5" L	6 pcs.	1



STRAIGHT SHANK MASONRY DRILL BIT

PART BIT1	3/16" Dia	3" Flute	4" L	1	5
PART BIT2	5/16" Dia	4" Flute	6" L	1	5
PART BIT3	3/8" Dia	4" Flute	6" L	1	5



CONCRETE SCREW MASONRY DRILL BIT

PART BIT4	3/16" Dia	2" Flute	3 1/2" L	1	5
PART BIT5	3/16" Dia	3" Flute	4 1/2" L	1	5
PART BIT6	3/16" Dia	4" Flute	5 1/2" L	1	5



SDS CARBIDE MASONRY DRILL BIT

PART BIT7	3/16" Dia	4 1/2" Flute	6 1/2" L	1	5
PART BIT8	5/16" Dia	4 1/4" Flute	6 1/4" L	1	5
PART BIT9	3/8" Dia	4 1/4" Flute	6 1/4" L	1	5



RECIPROCATING SAW BLADE

6" BLADE, 5 BLADES PER PACK

- 14 teeth per inch
- DeWALT DW4808

PART DW4808
6" 14 TPI Straight Back
Bi-Metal

1

- 24 teeth per inch
- DeWALT DW4813

PART DW4813
6" 24 TPI Straight Back
Bi-Metal

1

- 6 teeth per inch
- DeWALT DW4802

PART DW4802
6" 6 TPI Taper Back
Bi-Metal

1



CUTOFF WHEEL

25 WHEELS PER PACK



- 4 1/2" Dia, .045" thick, 7/8" arbor
- Maximum RPM: 13,300
- Recommended use: metals
- DeWALT DW8062

PART DW8062
4 1/2" x .045 x 7/8"
Metal Cutting

1



RACK STRAP

SOLD IN PACKS OF 2, 8' POLYESTER STRAP WITH DOUBLE J HOOK

PART RS1B2
Angle Mount For
Square Tubing

1

PART RS2B2
Curved Mount For
1 7/8" Tubing

1

PART RS3B2
Curved Mount For
2" Tubing

1

PART RS5B
Rack Strap with Van Rack Adapter
Crossbar, Black

1

- Sold each
- American van crossbar and many more

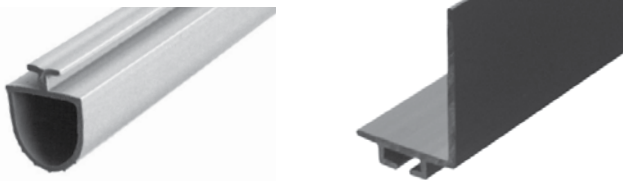

"T" BOTTOM SEAL

MINI WAREHOUSE

- 7/16" T Mini Warehouse Bottom Seal - Bulb (WD)
- Bulb size: 2 9/32"

directship

PART WD716

WD716	150'	Gray
1	3	6

- 25 pieces per box
- T width: 3/8"

directship

PART URS-100

URS1008	8'	Black
1	3	6
URS1009	9'	Black
1	3	6
URS10016	16'	Black
1	3	6

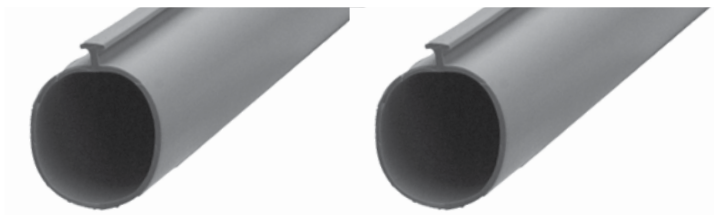

- 7/8" diameter
- T width: 3/8"



PART 1258

Roll-Up	200'	Gray
1	3	6

- T width: 3/8"
- Bulb size: 1 1/16"

directship

PART MW375

MW375	200'	Gray
1	3	6

- T width: 5/16"

directship

PART TB050

1/2" T Bulb	200'	Gray
1	3	6

PART

1" T Bulb	200'	Gray
1	3	6

PART TB150

1 1/2" T Bulb	150'	Gray
1	3	6



SLIDE BOLT LATCH

MOST INCLUDE FASTENERS

- Special "E" Coat finish
- Universal fit for corrugated and flat surface applications including U.S. Door and Trachte

PART 1252

Flat Door Latch (no wings) - Zinc
1 10 50

- 9 1/2"W x 3 1/4"H
- 12 gauge steel
- Suitable for Roll-Lite, Roll-Right, Wayne-Dalton, Trac-Rite, EPIC roll-up style doors

PART 1250

Flat Door Latch - Zinc
1 10 50

- Special "E" Coat finish
- Universal fit for corrugated and flat surface applications including U.S. Door and Trachte

PART 1253

Flat Door Latch (no wings) Stainless Steel
1 10 50

- 9 1/2"W x 3 1/4"H
- 12 gauge steel
- Suitable for Roll-Lite, Roll-Right, Wayne-Dalton, Trac-Rite, EPIC roll-up style doors

PART 1251

Flat Door Latch - Stainless Steel
1 10 50



- Double Zinc with "E" Coat finish
- Fits Betco, D.B.C.I., Janus, U.S. Door and Porvene applications

PART 1254

Four Bolt Door Latch - Zinc
1 10 50

- Fits Betco, D.B.C.I., Janus, U.S. Door and Porvene applications

PART 1255

Four Bolt Door Latch - Stainless Steel
1 10 50

- Double zinc plating with "E" coat finish
- Fits Betco, D.B.C.I., Janus, US Door, and Porvene corrugated doors
- Doesn't include lock cylinder (see #1247)

PART 1248

Bezel Four Bolt Door Latch - Zinc
1 10 50

- Double zinc plating with "E" coat finish
- Fits Roll-Lite, Roll-Right, Pilot, Trac-Rite, Wayne-Dalton, and Epic corrugated doors
- Doesn't include lock cylinder (see #1247)

PART 1249

Bezel Two Bolt Door Latch - Zinc
1 10 50



SLIDE BOLT LATCH

DOES NOT INCLUDE FASTENERS

- 4 1/4"W x 2 1/2"H x 3/8"Dia rod
- Suitable for swing or sectional doors

PART 1256

Chicago Slide Bolt Latch - Zinc
1 10 100

- 2 1/2"W x 3/4"D zinc plated
- Can use two padlocks with #1256
- Use with manager's overlock

PART 1257

Double Lock Plate - Red
1 10 50

- 1/2" diameter bolt
- Suitable for swing or sectional doors

PART CQ42

Heavy Duty Bolt Latch - Zinc
1 25

- 1/2" diameter bolt
- Allows manager's overlock
- Extra shield prevents traditional padlock cutting

PART CSSL1

Heavy Shielded Slide Bolt Latch - Zinc
1 25



LATCH ACCESSORIES

- 21 pins allow thousands of different key changes, anti-pick
- Does not access tenant's unit

PART 1247

Red Line Cylinder Lock

1 10 50

- 21 pins allow thousands of different key changes, anti-pick
- Does not access tenant's unit

PART 12472PK

Red Line Cylinder Lock,
2 Pack - Keyed Alike

1 10 50



- When activated the key disables the tenant's key from accessing unit
- Only works with Red Lined Cylinders (part 1247 & 12472PK)

PART 1245

Overlock Key for
Red Lined Cylinder

1



- Includes 3 keys
- 2 3/4" disc diameter
- 6 solid brass pin cylinder with anti-pick mushroom tumbler

PART 1246

Stainless Steel Disc Lock

1 25



- Mounts on the door jamb face
- Fasteners not included
- Works with part 1256, CQ42, & CSSL1

PART CFH1

Surface Mount Strike

1 10



LIFT HANDLE

CLOSED GRIP



PART 273

Lift Handle

1 100 200



Mini Warehouse End



Mini Warehouse End On The Side



SPRINGS

MINI WAREHOUSE

- Priced per pound, springs billed at 5 lb minimum

TO ORDER PLEASE SPECIFY:

- Wire size
- Inside diameter
- Length of spring
- Wind of spring (left or right wound)
- Choose end type

See pages 8-10 for further ordering details

WINDING CHART



Left Hand Wound



Right Hand Wound



CALL US TO ORDER

This item involves assistance. Call us to place your order at 833.SSC.DOOR

MINI WAREHOUSE



MYSTIC - CLASSIC

WITH A CLICK OF A BUTTON YOU CAN NOW ENTERTAIN OUTSIDE IN AN AIRY, PEST FREE ENVIRONMENT

- Frames available in white, beige and bronze
- Standard screens available in black or white PVC coated polyester
- Upgraded screens available in suntex80 or suntex90 black, stucco, beige, brown, dark bronze, and gray
- Also available upgrade screen to clear vinyl Weblon
- Available in surface or recessed mount
- Surface mount is 4½" wider and 8½" taller than opening
- Recessed mount is exact opening size
- Standard features: 6' extension cord, 6 channel remote control, ¾" felt
- Upgrade options: 8' and 16' extension cord, 6 and 16 channel remote control, 1¼" felt
- Made to order 3 - 4 weeks shipping time



ELECTRONICS

INCLUDES ONE HAND HELD REMOTE

PART MST1 Hand Held Remote 1 Channel	1	PART MSWMT6 Wireless Wall Mount 6 Channel	1
PART MST6 Hand Held Remote 6 Channel	1	PART MSWMT16 Wireless Wall Mount 16 Channel	1
PART MST16 Hand Held Remote 16 Channel	1		





LIFESTYLE SCREEN

DIVERSIFY YOUR PRODUCT OFFERING AND INCREASE YOUR ADD-ON SALES POTENTIAL! GO FROM GARAGE TO AIRY, PEST-FREE SPACE AND BACK AGAIN IN SECONDS!



- Your Lifestyle Screen is now safely shipped in a protective PVC tube to ensure there is no bending or rips.
- Rugged 2" x 2" architectural grade aluminum frame
- Operates on track, independent from garage door

- Spring loaded counterbalance system
- The Standard Screen 18' x 14' fiberglass fabric has no shade factor
- The Superscreen 17' x 20' PVC Coated Polyester fabric is rated to block 60% of the sun's harmful UV rays, light and heat.

directship

WIDTH	HEIGHT	SCREEN TYPE	RETRACTABLE DOOR
6'-18'	7'	Standard Fiberglass	Yes/No
6'-18'	8'	Standard Fiberglass	Yes/No
8'-16'	9'	Standard Fiberglass	Yes/No
8'-16'	10'	Standard Fiberglass	Yes/No
6'-18'	7'	Super Screen	Yes/No
6'-18'	8'	Super Screen	Yes/No
8'-16'	9'	Super Screen	Yes/No
8'-16'	10'	Super Screen	Yes/No



Locked



Unlocked



ACCESSORIES

- Prevents small pets from pushing their way under the screen
- Designed to attach with button snaps to the center frame members
- Made of a PVC coated polyester
- 40"W x 32"H

PART PETKPR
Pet Keeper 1

PART SCRCLP
Screen Clips (Bag Of 20) 1

- Measures 30"L
- For use on the 7' models only (comes installed on 8' models)
- Designed to give the user height assistance

PART PSHBAR
Push Bar Assembly 1

- Consists of an upper and a lower slide bolt that fits into the t-groove on the pull bar of the Milano retractable door
- When activated the lock set keeps the pullbar from being opened
- Located on the inside of the retractable door unit

PART LOKBLK
Milano Door Lock Set - Black 1

PART LOKWHT
Milano Door Lock Set - White 1



LIFESTYLE SCREENS



CHASE VINYL STRIP DOORS

PROTECTING YOUR BUILDING FROM WEATHER & PESTS WHILE PROVIDING A CLEAR LINE OF SIGHT

Chase Door provides vinyl doors for any type of clearance, from pedestrian to forklifts. This light weight, small profile Econo Track has preset bolts making install easy and fast. Surface mount requires 6" above and 4" on each side of the door. Flush mounts align on the inside of the jamb on the header, lowering clearance by 2"-3".

Have an opening you need to clearly define? Ask about safety-orange ends to help signal forklifts and other equipment to the edges of the opening.

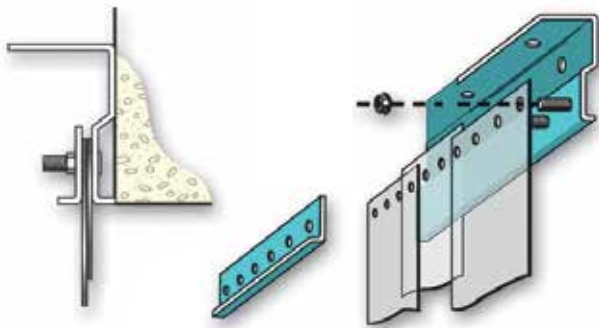

GENERAL APPLICATION	STRIP WIDTH x THICKNESS	Standard	USDA Low Temp	USDA Low Temp Reinforced	Color-rite (consult factory for color)	Amber-weld	Loc-Rib Standard	Loc-Rib USDA Low Temp	Safety Orange	Anti-Static	Red-weld
PERSONNEL For use in restaurants, walk-in coolers and small openings with minimal draft.	4" x .060"	■	■								
PERSONNEL-LIGHT CART For use in walk-through coolers, freezers and doorways with light cart traffic	6" x .060"	■	■	■							
LIGHT INDUSTRIAL For interior use with cart, pallet jack and light forklift traffic. Acceptable for small exterior doorways with some air movement and cold storage coolers and freezers.	8" x .080" (.120" available)	■	■	■	■	■	■	■	■	■	■
INDUSTRIAL Heavy lift-truck traffic in dock, doorways and cold storage coolers, or freezers. Acceptable for use in exterior doorways and dock enclosures. Provides good sound attenuation.	12" x .120" (.080" available)	■	■	■	■	■	■	■	■	■	■
HEAVY INDUSTRIAL Heavy duty lift-truck or vehicle traffic in large dock, door or craneway openings. Reduce sand, dust, chip, and wind penetration. Not designed for walk-through.	16" x .160" (.080" available)	■	■				■	■			

We can help **TEACH YOU THE ROPES**

You need answers to all of your questions – and you need them fast and from a knowledgeable source. Solutions Education is a free training program created by the experts at Service Spring to help educate the industry and provide you with standardized training – right at your fingertips. And you can get certifications with each course you complete. Use it anytime, anywhere.

“*I am impressed. I learned a lot of valuable information from watching these videos. They are short, concise and to the point. I hope more people take advantage of this great resource.*”

David H.





4.5" LAMINATED DOCK BUMPER

- Provides durable, economical protection
- Resists weathering and abrasions
- Constructed of fabric reinforced rubber
- Can be bolted or welded (19/16" bolt holes), bolts not included

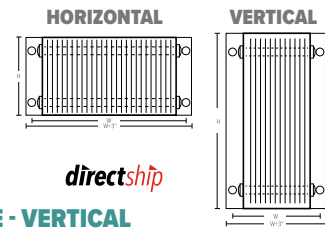

10" HIGH - HORIZONTAL

PART B451012	10"H x 12"W	1
PART B451014	10"H x 14"W	1
PART B451018	10"H x 18"W	1
PART B451024	10"H x 24"W	1
PART B451030	10"H x 30"W	1
PART B451036	10"H x 36"W	1
PART B451099A3	10"H x 96"W	1

12" HIGH - HORIZONTAL

PART B451214	12"H x 14"W	1
PART B451218	12"H x 18"W	1
PART B451224	12"H x 24"W	1
PART B451236	12"H x 36"W	1

6" HIGH - HORIZONTAL

PART B450624	6"H x 24"W	1
PART B450636	6"H x 36"W	1

11" WIDE - VERTICAL

PART B452011	20"H x 11"W	1
PART B452411	24"H x 11"W	1
PART B453011	30"H x 11"W	1
PART B453611	36"H x 11"W	1



6" LAMINATED DOCK BUMPER

10" HIGH - HORIZONTAL

PART B61012	10"H x 12"W	1
PART B61014	10"H x 14"W	1
PART B61018	10"H x 18"W	1
PART B61024	10"H x 24"W	1
PART B61030	10"H x 30"W	1
PART B61036	10"H x 36"W	1

12" HIGH - HORIZONTAL

PART B61212	12"H x 12"W	1
PART B61214	12"H x 14"W	1
PART B61218	12"H x 18"W	1
PART B61224	12"H x 24"W	1
PART B61236	12"H x 36"W	1
PART B61299A3	12"H x 96"W	1

11" WIDE - VERTICAL

PART B62011	20"H x 11"W	1
PART B62411	24"H x 11"W	1
PART B63611	36"H x 11"W	1



9" LAMINATED DOCK BUMPER

10" HIGH - HORIZONTAL

PART 91014*	10"H x 14"W	1
PART 91024*	10"H x 24"W	1
PART 91036*	10"H x 36"W	1

11" WIDE - VERTICAL

PART 92011*	20"H x 11"W	1
-------------	-------------	---



directship Width Equals:
Bolt Hole Center to
Bolt Hole Center

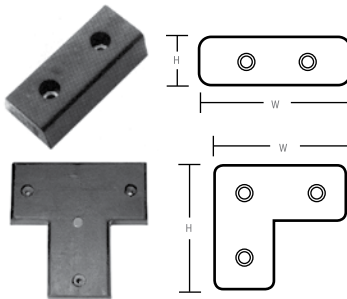

directship



SPECIALTY MOLDED BUMPER

- Composed of fiber reinforced rubber
- Resists weathering, warping, or hardening
- High impact resistance and long life
- Pre-drilled, countersunk mounting holes
- 3/4" anchor bolts required for mounting, bolts not included

4.5" HIGH - 3" PROJECTION

PART MDBE10	1
PART MDBE20	1
PART MDBE30	1

'L' SHAPED - 4" PROJECTION

PART MLG	1
----------	---

'T' SHAPED - 3" PROJECTION

PART MT322	1
------------	---

12" HIGH RECTANGULAR

PART MB1224	1
PART MBB12246	1

RECTANGLE - 2" PROJECTION

PART MM2818	1
-------------	---

directship

*Bumpers are manufactured by Durable Corp and ship UPS or LTL Class 55, F.O.B. Norwalk, Ohio 44857

DOCK EQUIPMENT

143

All Pricing Subject To Change



WHEEL CHOCK *directship*

PART WC689B
Molded Rubber Chock
9½"W x 6"H x 8"D 1

PART WC897B
Molded Rubber Chock
7"W x 7¾"H x 10"D 1

PART WC888B
Laminated Rubber Chock
8"W x 8"H x 8"D 1

PART CHAIN15WCL
Heavy Duty, 15' Chain with Hanger
¾" Thick 1

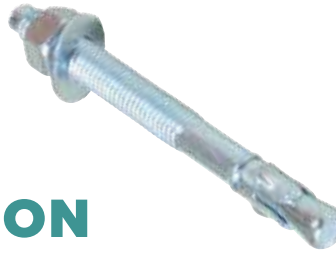

BUMPER INSTALLATION HARDWARE *directship*

• 6" and 10"H laminated bumpers require (4) AS-344
• 12"H laminated bumpers require (6) AS-344

PART BIT34
Masonry Bit ¾" 1

PART AS344
Concrete Anchor Bolt ¾" x 4"
Laminated Bumpers 1

PART AS346
Concrete Anchor Bolt ¾" x 6"
Molded Bumpers 1



DOCK LEVELER



BRUSH SEAL & HOLDER

• Priced per foot
• Clear Flange

directship

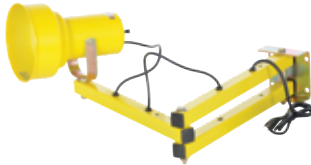

LOADING LIGHT *directship*

• Light bulbs not included

PART LL24
Double Strut, Single
Arm - 24" 1

PART LL40
Double Strut, Double
Arm - 40" 1

PART LL60
Double Strut, Double
Arm - 60" 1

90° FLANGE ANGLE

PART B290CLA05BL
1¼" Holder, ½" Brush LF 1

PART B290CLA10BL
1¼" Holder, 1" Brush LF 1

PART D490CLA09BL
1½" Holder, 1" Brush LF 1

PART D490CLA12BL
1½" Holder, 1¼" Brush LF 1

PART D490CLA16BL
1½" Holder, 1½" Brush LF 1

PART D490CLA20BL
1½" Holder, 2" Brush LF 1



OVERHEAD DOOR TRACK PROTECTOR *directship*

• Prevent costly damage to overhead door vertical track
• Solid steel angle construction, 6" base with ⅝" mounting holes

TRACK PROTECTORS SOLD INDIVIDUALLY

PART DSP36
6" Base Plate with 3"
Notch - 36" 1

PART DSP48
6" Base Plate with 3"
Notch - 48" 1

PART AS125
Individual Wedge Anchor
½" x 5½" 1

PART AS1254PK
4 Pack Wedge Anchor
½" x 5½" 1

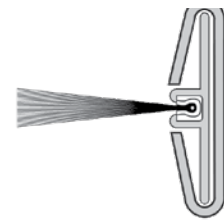

• 16' Dock Lever Kit (2 pcs. 96"ea)
• Priced as kit
• Steel Weldable

T FLANGE

PART BT90CLA10BLKITS
½" Holder, 1" Brush 1

PART BT90CLA14BLKITS
1½" Holder, 1½" Brush 1



CALL US TO ORDER

This item involves assistance.
Call us to place your order at
833.SSC.DOOR.

directship

Drop-shipped direct from the manufacturer Richmond IN 47374, USA Ships UPS or LTL Class 70 96" Max. Length for UPS Shipments



SINGLE FOLDING GATE

PART SSG465	3'-4' x 6'	1
PART SSG470	3'-4' x 6.5'	1
PART SSG475	3'-4' x 7'	1
PART SSG480	3'-4' x 7.5'	1
PART SSG485	3'-4' x 8'	1
PART SSG565	4'-5' x 6'	1
PART SSG570	4'-5' x 6.5'	1
PART SSG575	4'-5' x 7'	1
PART SSG580	4'-5' x 7.5'	1
PART SSG585	4'-5' x 8'	1
PART SSG665	5'-6' x 6'	1
PART SSG670	5'-6' x 6.5'	1
PART SSG675	5'-6' x 7'	1
PART SSG680	5'-6' x 7.5'	1
PART SSG685	5'-6' x 8'	1
PART SSG765	6'-7' x 6'	1
PART SSG770	6'-7' x 6.5'	1
PART SSG775	6'-7' x 7'	1
PART SSG780	6'-7' x 7.5'	1
PART SSG785	6'-7' x 8'	1
PART SSG865	7'-8' x 6'	1
PART SSG870	7'-8' x 6.5'	1
PART SSG875	7'-8' x 7'	1
PART SSG880	7'-8' x 7.5'	1
PART SSG885	7'-8' x 8'	1
PART SSG970	8'-9' x 6.5'	1
PART SSG975	8'-9' x 7'	1
PART SSG980	8'-9' x 7.5'	1
PART SSG1070	9'-10' x 6.5'	1
PART SSG1080	9'-10' x 7.5'	1



DOUBLE FOLDING GATE

PART PFG865	6'-8' x 6'	1
PART PFG870	6'-8' x 6.5'	1
PART PFG875	6'-8' x 7'	1
PART PFG880	6'-8' x 7.5'	1
PART PFG885	6'-8' x 8'	1
PART PFG1065	8'-10' x 6'	1
PART PFG1070	8'-10' x 6.5'	1
PART PFG1075	8'-10' x 7'	1
PART PFG1080	8'-10' x 7.5'	1
PART PFG1085	8'-10' x 8'	1
PART PFG1265	10'-12' x 6'	1
PART PFG1270	10'-12' x 6.5'	1
PART PFG1275	10'-12' x 7'	1
PART PFG1280	10'-12' x 7.5'	1
PART PFG1285	10'-12' x 8'	1
PART PFG1465	12'-14' x 6'	1
PART PFG1470	12'-14' x 6.5'	1
PART PFG1475	12'-14' x 7'	1
PART PFG1480	12'-14' x 7.5'	1
PART PFG1485	12'-14' x 8'	1
PART PFG1665	14'-16' x 6'	1
PART PFG1670	14'-16' x 6.5'	1
PART PFG1675	14'-16' x 7'	1
PART PFG1680	14'-16' x 7.5'	1
PART PFG1685	14'-16' x 8'	1
PART PFG1870	16'-18' x 6.5'	1
PART PFG1875	16'-18' x 7'	1
PART PFG1880	16'-18' x 7.5'	1
PART PFG2070	18'-20' x 6.5'	1
PART PFG2080	18'-20' x 7.5'	1

directship

**ILLINOIS
ENGINEERED
PRODUCTS**

Drop-shipped direct from the manufacturer Chicago, IL 60608

ADD EXTRA SAFETY

Secure outside access during the day and add security at night with heavy-duty 15 gauge steel folding gates. Durable 3" steel casters allow operator to quickly and fully retract gate when not in use. Center drop pin rests in pre-drilled hole to secure gate when extended. Easy installation! Lock is located on right side on single gates, from the outside of the building. Galvanized for durability.

**FOLDING
GATE**

All Pricing Subject To Change

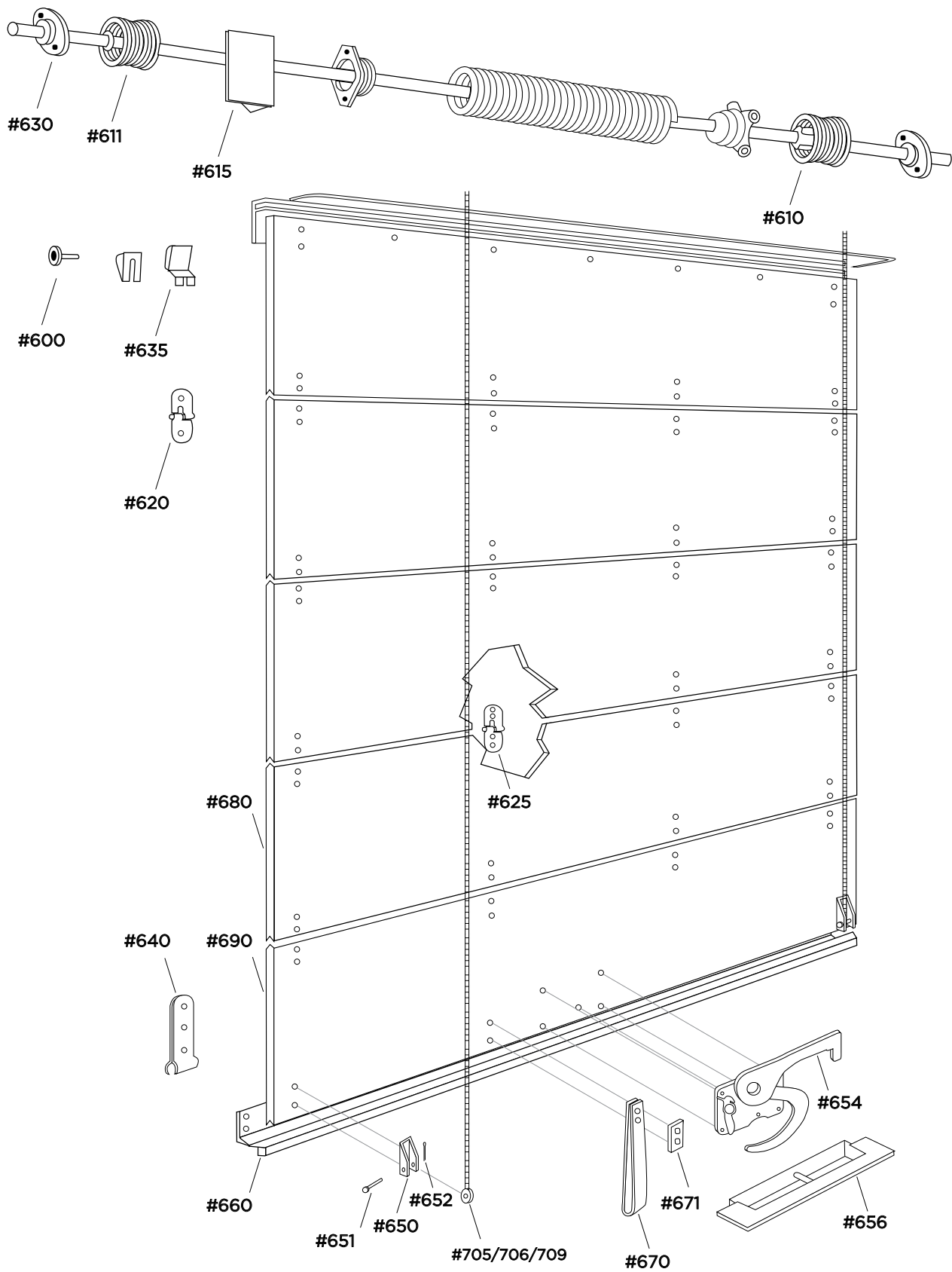

3/4" T-STYLE DOOR PARTS INDEX (1" ROLLERS) TRUCK TRAILER DOORS



ROLLER & DRUM

- 2¾" Stem
- 7/16" Shaft diameter

PART 600

1" Steel Roller
1 50 100



PART 610

3" Drum LH (Curbside)
1 10

PART 611

3" Drum RH (Roadside)
1 10



PART 608

1" Raw Track - 8' Section 1



HINGE

PART 620

End Hinge
1 50 100



PART 625

Center Hinge
1 50 100



BOTTOM SEAL

PART 660

Bottom Seal Only - 98" 1



BRACKET & FIXTURE

PART 630

Bearing Assembly 1



PART 615

Spring Anchor Bracket 1



PART 650

Cable Anchor Bracket 1



PART 635

Top Fixture - Complete 1



PART 640

Bottom Fixture 1



PART 645

Step Bolt - ¼" x 1¼"
1 100



LOCK

PART 654

Maximum Security Lock 1

PART TG69572

Keeper for Maximum Security Lock 1



PART 656

Catch Box 1



PART 670

Pull Strap 1 per inch

PART 671

Pull Strap Retainer 1



CABLE ASSEMBLY

- ½", 7 x 19 Stainless Steel
- ¼" eye
- Sold in Pairs

PART 705

Cable Assembly 110" Red 1

PART 706

Cable Assembly 115"- Blue 1

PART 709

Cable Assembly 130"- Orange 1



PIN

PART 651

Cable Anchor Pin 1



PART 652

Cotter Pin - 3/32" x 1" 1



NUT

PART 646A

¼" Keps Nut 1

PART 796

¼" Keps Nut (1,000 pcs)
1 5

PART 796-250

¼" Keps Nut (250 pcs)
1 5

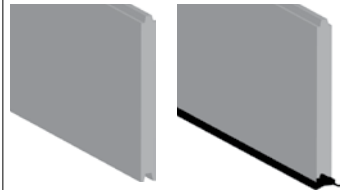

SECTION

ALL PANELS:

- ¾" wood, prime painted
- Tongue and groove
- Panels can be field cut to desired width
- Panels require ½" router bit for center hinge and ¾" bit for end hinge
- Ships via LTL

BOTTOM PANEL INCLUDES:

- Bottom seal and retainer
- Bottom fixtures and cable anchor
- Lift handle, pull strap and retainer

PART 680

Intermediate - 15" x 98" 1

PART 682

Intermediate - 11" x 98" 1

PART 690

Bottom T-Style - 15" x 98" 1

PART 693

Bottom T-Style - 11" x 98" 1



LEARN MORE

Scan this code to learn how to ORDER A TRUCK TRAILER DOOR by watching this video!

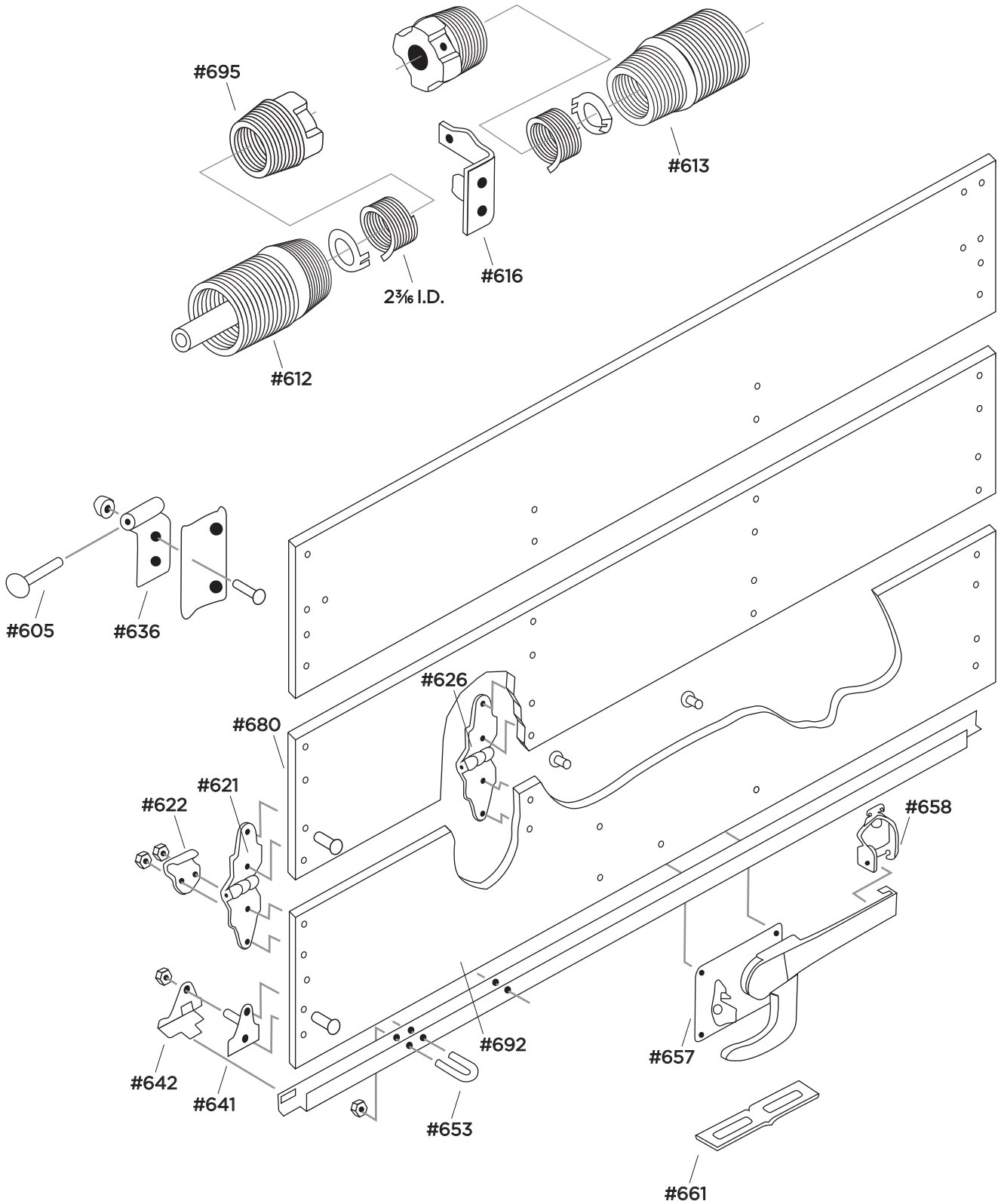

3/4" W-STYLE DOOR PARTS INDEX (2" ROLLERS)
TRUCK TRAILER DOORS



ROLLER & DRUM

PART 605



PART 695
Winding Cone for 2 3/16" ID 1



PART 612
3" Roadside LHW Aluminum Drum with Bearing 1

PART 613
3" Curbside RHW Aluminum Drum with Bearing 1



HINGE

PART 621
End Hinge with Cover Clamp
1 20 100



PART 622
Cover Clamp for End Hinge
1 20 100



PART 626
Center Hinge 1



BRACKET & FIXTURE

PART 616
Center Balancer Bracket 1



PART TG2526
Works with part 616, Center Balancer Bracket 1



PART 641
Bottom Fixture with Roller Clamp 1



PART 642
Bottom Fixture Roller Clamp 1



PART 636
Top Fixture - Complete 1



PART 653
U-Bolt Anchor-1 1/4" 1



LOCK

PART 657
Outside Cam Lock 1



PART 661
Latch Plate 1



PART 658
Handle Keeper 1



CABLE ASSEMBLY

- 1/8", 7 x 19 Stainless Steel
- 7/16" eye
- Sold in Pairs

PART 707
Cable Assembly
105"- Yellow 1

PART 708
Cable Assembly
115"- Green 1

PART 710
Cable Assembly
125"- Black 1

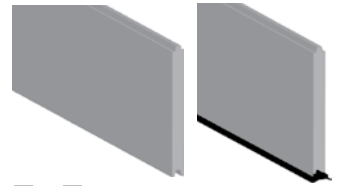

SECTION

ALL PANELS:

- 3/4" wood, prime painted
- Tongue and groove
- Panels can be field cut to desired width
- Panels require 1/2" router bit for center hinge and 3/4" bit for end hinge
- Ships via LTL

BOTTOM PANEL INCLUDES:

- Bottom seal and retainer
- Bottom fixtures and cable anchor
- Lift handle, pull strap and retainer

PART 680
Intermediate - 15" x 98" 1

PART 682
Intermediate - 11" x 98" 1

PART 692
Bottom - 15" x 98" 1



PVC SPRING FILLER

- PVC spring filler for 2 3/16" ID up to 37"

PART TUBE37
PVC Spring Filler 1



LEARN MORE

Scan this code to learn how to ORDER A TRUCK TRAILER DOOR by watching this video!



T-STYLE 3/4" DRY FREIGHT WOOD DOOR

INCLUDES:

- 1" rollers, hinges and cables
- Bottom seal and header seal
- Installation instructions
- Prime painted, tongue and groove panels
- Cam Lock
- Ships within 2-3 weeks!

PART 9090T	90"
PART 90100T	100"
PART 90105T	105"
PART 90115T	115"

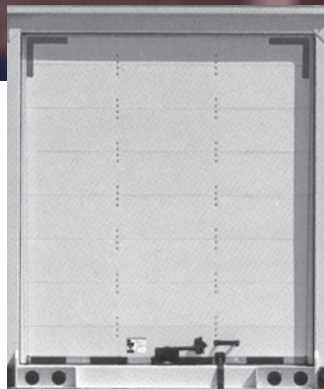

directship

W-STYLE 3/4" DRY FREIGHT WOOD DOOR

INCLUDES:

- 2" rollers, hinges and cables
- Bottom seal and header seal
- Installation instructions
- Prime painted, tongue and groove panels
- Cam Lock
- Ships within 2-3 weeks!

PART 9090W	90"
PART 90100W	100"
PART 90105W	105"



directship

T-STYLE 1/4" COMPOSITE DOOR

INCLUDES:

- 1" rollers, hinges and cables
- Tongue and groove design for maximum cargo protection
- Hardware is e-coated
- Composite panels are paintable
- 100% recyclable materials



PART C9877T	77"
PART C9889T	89"
PART C98105T	105"

W-STYLE 1/4" COMPOSITE DOOR

INCLUDES:

- 2" rollers, hinges and cables
- Tongue and groove design for maximum cargo protection
- Hardware is e-coated
- Composite panels are paintable
- 100% recyclable materials



PART C9877W	77"
PART C9889W	89"
PART C98105W	105"

T-STYLE TRUCK & W-STYLE TRUCK TRAILER DOORS

directship

*Drop-shipped direct from the manufacturer F.O.B. Carey, OH 43316.

PLEASE CONTACT THE ORIGINAL DOOR MANUFACTURER IF...

your door requires track or you are ordering by a door serial number. All door orders are nonreturnable and nonrefundable.

Made to your actual door width and height! Complete order form on next page.

Cust#: Date: _____
Bill To: _____

PO#: _____
Ship To: _____

Payment Method Open account (w/prior approval) Credit Card Check by Phone
Credit Card Number _____ EXP ____/____ CVV____
Authorized Signature _____

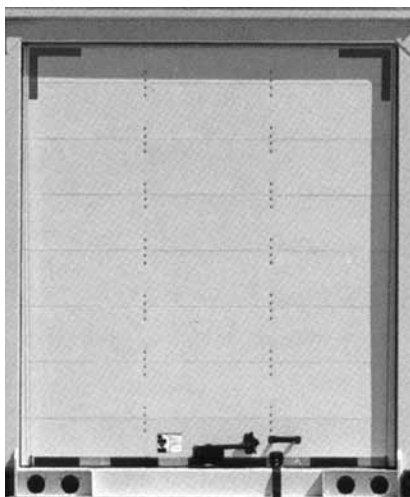

DOOR INCLUDES:

- Prime painted, tongue and groove panels
- Rollers
- Hinges
- Cables
- Cam Lock
- Bottom seal and header seal
- Installation instructions

Please provide accurate information for all required fields. All doors are made to exact measurements provided from this form.

STEP #1: Wood Composite

STEP #2: Identify Door Type:
Choose one: T-Style Door (1" Rollers)
 W-Style Door (2" Rollers)

STEP #3: Measure Actual Door Width & Height
Do not include any side seals or hardware in your measurement.
Actual door width = _____
Do not include top or bottom seals in your measurement.
Actual door height = _____

STEP #4: How Many Sections?
Total number of Sections = _____

STEP #5: Counterbalance System Required?
Choose one: Yes, include the counterbalance with my order
 No, I will reuse my existing counterbalance

STEP #6: Side Seals Required?
Choose one: Yes, include side seals
 No side seals required

STEP #7: For Wood Doors: Add White Enamel Finish?
Choose one: Yes, add white enamel finish
 No

Please contact the original door manufacturer if your door requires track or you are ordering by a door serial number. Doors are shipped direct from the manufacturer Class 70. Allow 2-3 weeks for delivery. All door orders are nonreturnable or refundable. Sorry, no COD orders accepted.

Request a Quote Place an Order (*sign below*)

By signing below you are stating this is an order placed for a truck door with Service Spring Corp. You, the customer, acknowledge that the information given is correct and once the order is placed, are responsible for full payment. Signature is required for order to be processed.

Signature _____ Print Name _____ Date _____



ONLINE QUOTE FORM

**T & W STYLE DOOR
QUOTE FORM**

Fax completed forms to 330.556.6686
or email sales@sscorp.com

Cust #: _____ Date: _____ PO #: _____
Bill To: _____ Ship To: _____

Payment Method Open account (with prior approval) Credit Card Check by Phone
Credit Card Number _____ EXP ____/____ CVV _____
Authorized Signature _____

SHIPPING METHOD

LTL: R&L Best Way **Other** Customer Pickup Other: _____

Prepared By: _____

ORDER/ARTWORK INFORMATION No artwork setup charge.
Minimum order of 10 cases is required. A signed approval of artwork is required for all orders.

Cases Ordered: _____

Can Size:
 14 oz can

Address or Signature Block (Exactly how it is to appear on the label):

Sold By: Exclusively Manufactured For:
 Distributed By: Other: _____

***= Required Field**

*Company Name: _____
*Address: _____
*City: _____ *State: _____ *Zip: _____

*Phone: _____ Fax: _____
Website: _____ E-mail: _____

Cap Color: No charge

(Part #434CAP)

Black
 Red
 Light blue

Orange
 Dark green
 Silver

Source of Artwork:

Customer e-mailing to: sales@sscorp.com
 Download logo from website
 Customer mailing
 Other: _____

Miscellaneous Comments: _____



Cust #: _____ Date: _____ PO #: _____
Bill To: _____ Ship To: _____

Payment Method Open account (with prior approval) Credit Card Check by Phone
Credit Card Number _____ EXP ____/____ CVV____
Authorized Signature _____

SHIPPING METHOD

LTL: R&L Best Way
Other: Customer Pickup Other: _____

Prepared By: _____

ORDER/ARTWORK INFORMATION

Minimum order of **18 cases** is required. A signed approval of artwork is required for all orders.

Cases Ordered: _____

Paper Label:

- Single color paper label (no artwork setup charge)
- Two color paper label (no artwork setup charge)
- Four color paper label (one time \$50.00 artwork setup charge, Part #449ART)

Address or Signature Block (Exactly how it is to appear on the label):

- Sold By: _____ Exclusively Manufactured For: _____
- Distributed By: _____ Other: _____

*= Required Field

*Company Name: _____

*Address: _____

*City: _____ *State: _____ *Zip: _____

*Phone: _____ Fax: _____

Website: _____ E-mail: _____

Cap Color: No charge

- White

Cap Color: \$1.80 per case (Part #449CAP)

- Black Red
- Orange Silver
- Dark green Light blue

Source of Artwork:

- Customer emailing to:
sales@sscorp.com
- Download logo
from website
- Customer mailing

Label Color choices (PMS):

- Red (185) Green
- Black Dark green (357)
- Orange (021) Purple
- Blue (072) Brown (469)
- Light blue (Process blue)

Miscellaneous Comments: _____



ONLINE QUOTE FORM

ULTRA GEL- PRIVATE LABEL QUOTE FORM

Fax completed forms to 330.556.6686
or email sales@sscorp.com

Cust #: _____ Date: _____ PO #: _____
Bill To: _____ Ship To: _____

Payment Method Open account (with prior approval) Credit Card Check by Phone
Credit Card Number _____ EXP ____/____ CVV _____
Authorized Signature _____

SHIPPING METHOD

LTL: R&L Best Way **Other:** Customer Pickup Other: _____

Prepared By: _____

ORDER/ARTWORK INFORMATION

Minimum order of **18 cases** is required. A signed approval of artwork is required for all orders.

Cases Ordered: _____

Paper Label:

- Single color paper label (no artwork setup charge)
- Two color paper label (no artwork setup charge)
- Four color paper label (one time \$50.00 artwork setup charge, Part #449ART)

Address or Signature Block (Exactly how it is to appear on the label):

- Sold By: _____ Exclusively Manufactured For: _____
- Distributed By: _____ Other: _____

*= Required Field

*Company Name: _____

*Address: _____

*City: _____ *State: _____ *Zip: _____

*Phone: _____ Fax: _____

Website: _____ E-mail: _____

Cap Color: No charge

- White

Cap Color: \$1.80 per case

(Part #449CAP)

- Black Orange
- Red Silver
- Light blue Dark green

Source of Artwork:

- Customer emailing to: sales@sscorp.com
- Download logo from website
- Customer mailing

Label Color choices (PMS):

- Red (185) Green
- Black Dark green (357)
- Orange (021) Purple
- Blue (072) Brown (469)
- Light blue (Process blue)

Miscellaneous Comments: _____

Z-45 PENETRATING LUBE PRIVATE LABEL QUOTE FORM

Fax completed forms to 330.556.6686
or email sales@sscorp.com



ONLINE QUOTE FORM



***= Required Field**

*Company Name: _____

*Address: _____

*City: _____ *State: _____ *Zip: _____

*Phone: _____ Fax: _____

Website: _____ E-mail: _____

Residential: _____ Commercial: _____

Swing: _____ Barrier: _____ Slide: _____

Model Number: _____

Single Gate Operation: _____ Dual Gate: _____

Voltage

115V Single Phase _____ 230V Single Phase _____

208V 3 Phase _____ 230V 3 Phase _____

460V 3 Phase _____ 575V 3 Phase _____

Other _____

Horsepower

1/2 HP: _____ 3/4 HP: _____ 1 HP: _____

Heater Required Loop Detectors Keyless Entry

Special Modifications: _____



ONLINE QUOTE FORM

**LIFTMASTER GATE
QUOTE REQUEST**

Fax completed forms to **330.556.6686**
or email **sales@sscorp.com**

Complete this form if you would like to get a quote on operators not listed in the Commercial Operator Section.

***= Required Field**

*Company Name: _____

*Address: _____

*City: _____ *State: _____ *Zip: _____

*Phone: _____ Fax: _____

Website: _____ E-mail: _____

Model #: _____

Horsepower: _____

Voltage: _____

Phase: _____

For Side Mount - Right or Left Mounting (inside view): _____

Type of Door: _____

Door Width: _____

Door Height: _____

Hi Lift: _____

Drive Sprocket Left or Right: _____

Door Shaft and Keyway: _____

Any Additional Modifications? : _____



***= Required Field**

*Company Name: _____

*Address: _____

*City: _____ *State: _____ *Zip: _____

*Phone: _____ Fax: _____

Website: _____ E-mail: _____

Please complete the following information:

1) Inches from pivot point to cable attachment _____

Chose one: Pivot weight: _____

Total weight _____

2) Drop from trailer to ground (need min of 7") _____

3) Set Back - Distance from drum location to door _____

Width of door _____

Drum number (if available) _____

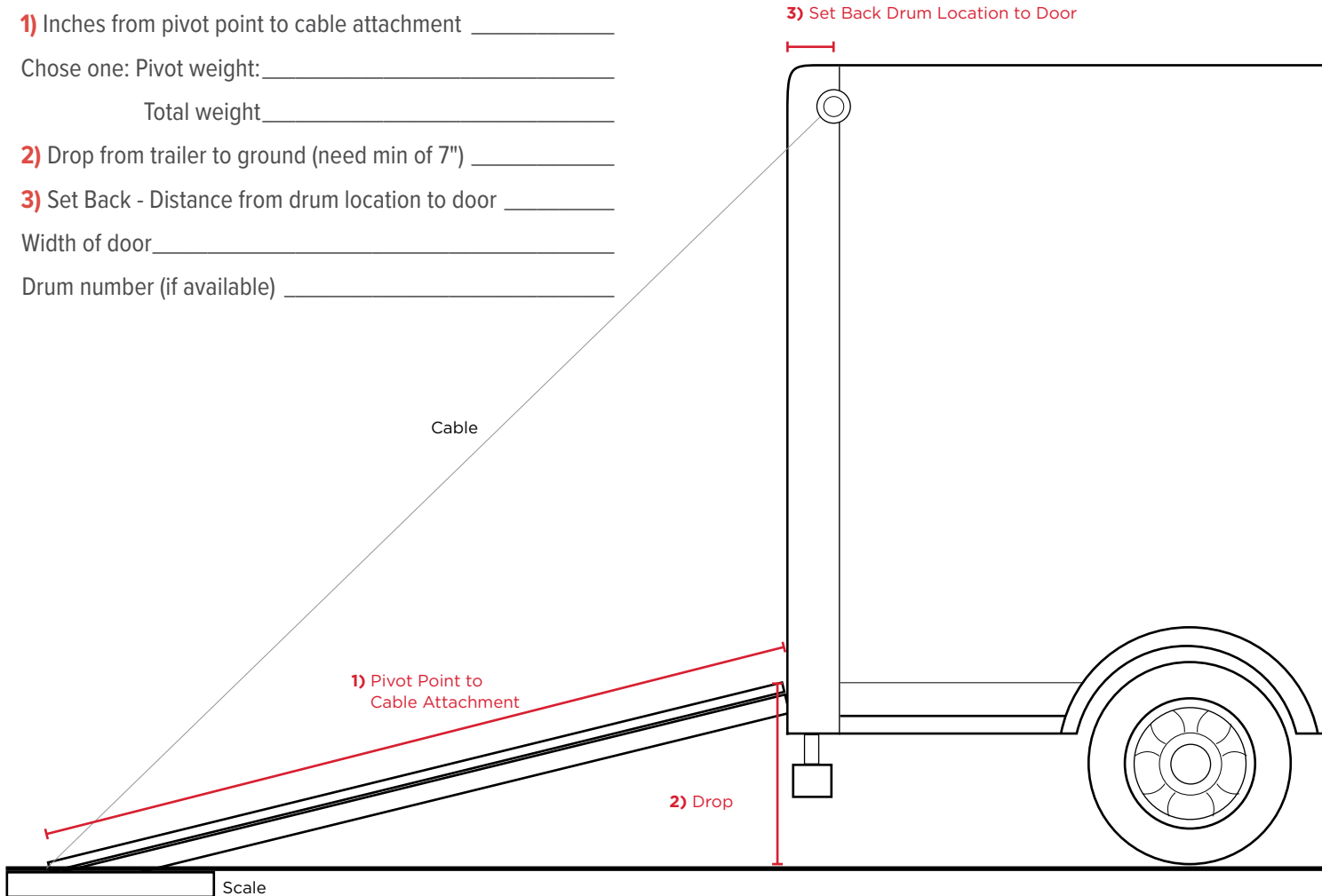

Total Weight = Door is at 90° Angle (Closed)
Pivot Weight = Door is resting on scale on ground (Open)



ONLINE QUOTE FORM

**TRAILER RAMP DOOR
QUOTE FORM**

Fax completed forms to 330.556.6686
or email sales@sscorp.com

Company Name: _____

Ordered By: _____

PO Number: _____

Cust #: _____ Date: _____

Bill To: _____ Ship To: _____

Opening measurements:

Width: _____

Height: _____

HOOD & Rail Color:

- White
- Beige
- Bronze

OPERATOR side: (OSLI)

- Right
- Left

Mounting Style:

- Recessed Mount
- Surface/Face Mount

Screen Fabric:

- White PVC/Polyester
- Black PVC/Polyester

UPGRADE OPTIONS *(additional charges will apply)*

Felt:

- 3/4" (Standard)
- 1-1/4"

Extension cord:

(6' with plug end included.)

- 8' Extension
- 16' Extension

Screen Fabric:

- clear vinyl/weblon

Suntex:*

- Suntex 80
- Suntex 90

Color:*

- Black
- Stucco
- Beige
- Brown
- Dark bronze
- Grey

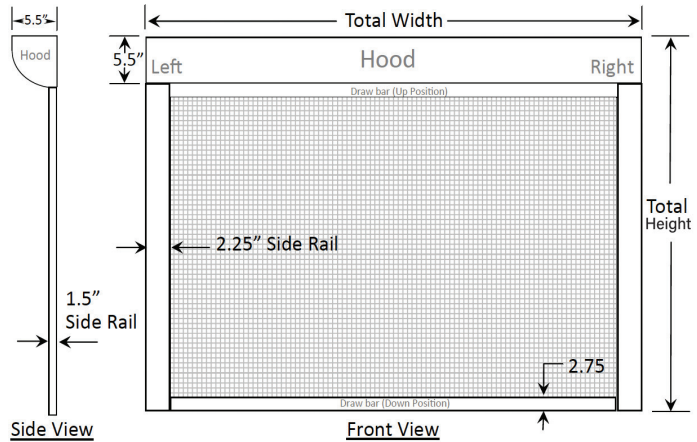

Special Instructions: _____

Request a Quote

Place an Order *(sign below)*

Mystic Screens are all custom made to exact specifications. By signing below you are stating this is an order placed for a Mystic Screen with Service Spring Corp. You, the customer, acknowledge that the information given is correct and once the order is placed, are responsible for full payment. Signature is required for order to be processed.

Signature _____ Print Name _____ Date _____



DOOR INFORMATION

Opening Width _____

Opening Height _____

MOUNTING TYPE

- Jamb/Under Lintel
- Face-to Wall Mount (surface mount)

Clearance Left _____

Clearance Right _____

Clearance Above _____

TRAFFIC TYPE

- Pedestrian
- Hand Cart
- Light Forklift
- Industrial
- Heavy Industrial

STRIP SIZE & OVERLAP OPTIONS AVAILABLE

- 4" Strip 50%
- 6" Strip 33% 67% 100%
- 8" Strip 25% 50% 75% 100%
- 12" Strip 33% 50% 67% 100%
- 16" Strip 25% 50% 75% 100%

MATERIAL TYPE

- Standard Clear
36°F to 150°F
- Standard Clear Loc Rib
36°F to 150° F
- Low Temp Clear Loc Rib
-20°F to 140° F

COMPANY INFORMATION

Company Name _____ Customer # _____

Mailing Address _____

City _____ State _____ ZIP _____

Phone _____ E-mail _____



ONLINE QUOTE FORM

CHASE VINYL STRIP DOOR QUOTE FORM

Fax completed forms to 330.556.6686
or email sales@sscorp.com

1 SENSING EDGE MODEL

For a **SECTIONAL** door, select an edge model.

DOOR THICKNESS	→	EDGE MODEL
1"	→	ME110
1 1/4" to 1 3/8"	→	ME112
1 1/2" to 1 5/8" →		ME113
1 3/4" to 2"	→	ME123
2"+	→	ME123 or MUxx*

*xx=custom W"xH", e.g. 3"x3" or 3"x4"

For a **ROLLING STEEL** door, select an edge model.

BOTTOM OF DOOR STYLE	→	EDGE MODEL
Double angle bottom bar	→	MT22
Solid piece	→	ME113 or ME123
Cornell door with T	→	MC22
Cornell door with double angle bottom bar	→	MT22

Model: _____

2 COLOR

If ME110, ME112, ME113 or ME123, select color:

 Black  Yellow (ME123 Only)

If MT22, MC22, MUxx, select color:

 Black  Gray  Yellow
 Y/B Stripe  XR5 (Yellow)

Color: _____

3 OUTLET LOCATION

Face the side of the door the operator is mounted to (inside/outside). Is the operator mounted on the left or right side of the door? This will be the handing for the edge. Select the appropriate outlet location.

If ME110, ME112, ME113, ME123, select handing:

If MT22, MC22, MUxx, select handing:



- Universal
- End
- Left
- Right

4 ACTIVE LENGTH

For a **SECTIONAL** door, measure the width of a sectional panel to determine the length of the edge.

For a **ROLLING STEEL** door, measure from the tip of one guide to the tip of the opposite guide, then subtract 2-inches (ensures active edge doesn't rub on guides) to determine the length of the edge.

_____ Ft. _____ in.
(1/4" increments)

5 MONITORING

Select a  **Monitored** sensing edge:

- If monitored photo optics are not installed and the door operator was manufactured after August 2010

Select a  **Non-Monitored** sensing edge:

- If monitored photo optics are installed
- If monitored photo optics are not installed and the door operator was manufactured before August 2010

- Monitored
- Non-Monitored

6 SWITCH CONFIGURATION

If you selected a  sensing edge, select:

- **2-wire**  **Monitored** configuration for most monitored applications
- **4-wire**  **Monitored** configuration if you have a LiftMaster operator and a CPS-EI interface (skip step 7)

If you selected a  Non-Monitored sensing edge, select:

- **2-wire**  **Non-Monitored** configuration (skip step 7)

Other **Non-Monitored** sensing edge options:

- Air-Wave Non-Monitored sensing edge (skip step 7)
- Pneumatic Non-Monitored sensing edge (skip step 7)

- 2-Wire Monitored
- 4-Wire Monitored
- 2-Wire Non-Monitored
- Air-Wave Non-Monitored
- Pneumatic Non-Monitored

7 MONITORING METHOD

If **2-wire**  **Monitored** switch configuration, select monitoring method based on operator brand:

Model	Termination	Operator Brand
T1 (green)	8.2K Resistor	Typically European commercial door operator brands
T2 (blue)	10K Resistor	Cookson, Cornell/US Gear, Lawrence, Linear,* LiftMaster/ Chamberlain,* Manaras,* Micanan,* Raynor,* VE Power Door*
T3 (red)	Diode Capacitor	Overhead Door/Genie**

*Requires SM-102 Signature Module for operator compatibility

**Requires SM-101 Signature Module for operator compatibility

- T1
- T2
 SM-102*
- T3
 SM-101**



1 SENSING EDGE MODEL



For standard protection.

SURFACE THICKNESS	→	EDGE MODEL
1"	→	MG110
1 ¼" to 1 ⅜"	→	ME120
1 ¾" to 2"	→	MG123



For 3-sided protection.

SURFACE THICKNESS	→	EDGE MODEL
±2" Gate Post	→	MGO20
2" Round Gate Post	→	MGR20
2" Square Gate Post	→	MGS20

Model: _____

2 COLOR

If MG110 or MG123, select color:

Black

If ME120, MGO20, MGR20 or MGS20, select color:

Black

Yellow

Color: _____

3 OUTLET LOCATION

Facing the operator side of the gate (inside/outside) determine the appropriate outlet location:

- If the edge is to be **mounted horizontally**, is the operator mounted on the left or right side?
- If the edge is to be **mounted vertically**, should the wire outlet be on the top or bottom?

If ME120, MGO20, or MG123, select handing:

If MGR20 or MGS20, select handing:



Universal

End

Left

Right

MG110 (End Only)

4 ACTIVE LENGTH

- If the edge is to be **mounted horizontally**, measure the width of the gate, subtracting for post caps.
- If the edge is to be **mounted vertically**, measure the full height of the gate post, subtracting for post caps (required not to exceed 6' in height)

NOTE: MG110, MGO20, MGR20, MGS20 models that exceed 6 feet in length will incur a UPS large package surcharge.

_____ Ft. _____ in.
(¼" increments)

5 SWITCH CONFIGURATION

Select the appropriate monitoring for the entrapment zone:

- **2-wire** **Monitored** edge if the operator was manufactured after January 2016
- **2-wire** **Non-Monitored** edge if the operator was manufactured before January 2016 (Skip to step 6.)

2-Wire Monitored

2-Wire Non-Monitored

6 MONITORING METHOD

If you selected **2-wire** **Monitored** switch configuration, select a **T2** (10K resistive) sensing edge.

Model	Monitoring Method	Operator Brand
T2	10K Resistive	AutoGate, B&B Armr Corporation, BFT US, Inc., Door King, GTO/Linear, Power Master/VE Power, Rotary, USAutomatic, Viking

T2

A For **hardwired edges**, select a **T2** sensing edge and also order the required module for compatibility with the following operator brands:

Module	Monitoring Method	Operator Brand
GEM-102	2-Wire Pulsed	IQ Gate (2/4-Wire)
GEM-103	4-Wire Pulsed	Eagle Access Control, IQ Gate (2/4-Wire), Nice, PPA America
GEM-104	Normally Closed	All-O-Matic, Beninca, Byan Systems, FAAC, HySecurity, Maximum Controls, Ramset, SEA USA, V-Mag

Modules

GEM-102

GEM-103

GEM-104

B For **wireless edges**, select a **T2** sensing edge and also order an **RBand**, monitored wireless edge system (no module is required with wireless installations):

Module	Includes	Operator Brands
RB-G-K10	1 each: RB-RX10 (receiver) + RB-TX10 (transmitter)	Compatible with all operator brands
RB-TX10	Order up to 5 transmitters (6 total transmitters/edges)	

Wireless

RB-G-K10

___ RB-TX10 (up to 5)



ONLINE QUOTE FORM

MILLER EDGE
QUOTE FORM FOR GATE

Fax completed forms to **330.556.6686**
or email **sales@ssc corp.com**

I (we) hereby authorize Service Spring Corp. or Service Spring West, Inc., (The Company) to initiate debit entries to my (our) bank account (The Financial Institution), and if necessary, initiate adjustments for any transactions credited/debited in error. This authority will remain in full effect until The Company is notified by me (us) in writing to cancel it in such time as to afford The Company and The Financial Institution a reasonable opportunity to act on it.

I (we) agree to an insufficient funds fee of \$35.00 per transaction if our bank account is charged by The Company and the balance is insufficient to make payment in full. I (we) also agree to pay all late fees and any collection fees if needed to collect amounts due to insufficient funds in my (our) account.

Company Name: _____ Customer #: _____
Mailing Address: _____ Shipping Address (if different from mailing): _____
City: _____ City: _____
State: _____ ZIP: _____ Country: _____ State: _____ ZIP: _____ Country: _____
Phone Number: _____ Email: _____

Business Operates as: Corporation Partnership LLC Proprietorship

FINANCIAL INSTITUTION INFORMATION

Financial Institution Name: _____
Address: _____
City: _____ State: _____ Zip: _____
Phone: _____ Bank Contact Name: _____

Checking Savings Transit/ABA Number: _____ (9 digits)
Account #: _____

Signature Owner/Officer: _____ Date: _____
Print Name: _____

TAX EXEMPTION: No Yes **If you are tax exempt,** please attach a copy of your Exemption Certificate

ATTACH A VOIDED CHECK HERE

DO NOT attach a Deposit Slip, because they do not show the necessary information
You may contact our Accounting Department during normal business hours (7:30-4:30 EST) with any inquiries (866.705.5979).

Joan Doe
Anywhere, USA

PAY TO THE ORDER OF _____ \$ _____
DOLLARS

YOUR BANK
Anywhere, AB 12345

FOR _____

000000000 000000000000

VOID



COMPANY INFORMATION

Company Name: _____

Date of Request: _____

Mailing Address: _____

Shipping Address (if different from mailing): _____

City: _____

City: _____

State: _____ ZIP: _____ Country: _____

State: _____ ZIP: _____ Country: _____

Phone Number: _____

FAX Number: _____

E-mail: _____

Accounts Payable Contact: _____

Business Operates as: Corporation Partnership LLC Proprietorship

Federal Tax ID Number: _____

Date Business Established: _____

Parent Company: _____

Number of Employees: _____

Annual Sales Volume: \$ _____

Credit Limit Requested: \$ _____

Anticipated Monthly Purchases: \$ _____

TAX EXEMPTION: No Yes *If you are tax exempt, please attach a copy of your Exemption Certificate*

BANK REFERENCE

Bank Name: _____

Phone: _____

Contact: _____

Your D&B D-U-N-S® Number: _____

TRADE REFERENCES (List only those which you currently purchase on Open Account —*Required)

- *Name: _____ *Phone: _____ *Fax: _____
Address: _____ City: _____ State: _____ Zip: _____
- *Name: _____ *Phone: _____ *Fax: _____
Address: _____ City: _____ State: _____ Zip: _____
- *Name: _____ *Phone: _____ *Fax: _____
Address: _____ City: _____ State: _____ Zip: _____

Applicant(s) signature attests to the financial responsibility, ability, and willingness to pay invoices in accordance with Service Spring Corp's (SSC) Net 30 day payment terms from date of invoice. The above information is for the purpose of obtaining credit and is warranted to be true. All past due invoices are subject to a finance charge of 1 1/2% per month. I/we shall be responsible for all collection costs and legal fees in connection with any delinquent amount referred to a third party. Should credit availability be granted by SSC, all decisions with respect to the extension or continuation shall be in the sole discretion of SSC. Credit availability may be terminated by SSC within its sole discretion. By signing below applicant authorizes trade and bank references listed in this application to release information necessary to establish a line of credit.

Printed Name: _____

Signature: _____

Title: _____

Date: _____

PERSONAL GUARANTEE (Required of Sole Proprietors, LLC's, and Partnerships)

In consideration of Service Spring Corp (SSC), extending credit to the above named entity and any of its subsidiaries or related parties, the undersigned do(es) hereby individually, and jointly and severally, PERSONALLY GUARANTEE PAYMENT to SSC, and any or all of its successors of all amounts which may become due pursuant to sales of goods. This includes any and all charges, including freight, and services fees incurred in the process of extending credit and all reasonable attorney fees, plus court costs and all other costs of collection and litigation. This guarantee is open, continuing, absolute, and unconditional and shall continue in full force and may be revoked only by SSC. In the event that SSC, has to file suit against the above named entity or the undersigned, the undersigned agrees to all conditions contained in the above.

Guarantor: _____
Signature

Witness—Signature

Printed Name

Witness—Printed Name

Title

Date

SS# (Required) Date of Birth

Date



DOWNLOAD FORM

**ACCOUNT
APPLICATION**

Fax completed forms to 330.476.2757
or email credit@ssccorp.com

Cust #: _____ Date: _____

Bill To: _____ Ship To: _____

Payment Method: Open account (w/prior approval) Credit Card Check by Phone

Credit Card Number: _____ EXP: ____/____ Signature: _____

SHIPPING METHOD

UPS: Ground 3rd Day Select 2nd Day Air Next Day Air

LTL: R&L

Other: Customer Pickup Location:

Special Instructions: _____ Prepared By: _____

*See Winding Chart on page 10

TORSION SPRINGS

QTY	HAND			WIRE	I.D.	LENGTH	CONES		COATED		SPEC. ENDS	SHAFT		PO#/JOB NAME
	Circle One						Circle One	Circle One	Circle One	Circle One		Circle One		
	RHW	LHW	PR				Yes	No	Yes	No		1"	1-1/4"	
	RHW	LHW	PR				Yes	No	Yes	No		1"	1-1/4"	
	RHW	LHW	PR				Yes	No	Yes	No		1"	1-1/4"	
	RHW	LHW	PR				Yes	No	Yes	No		1"	1-1/4"	
	RHW	LHW	PR				Yes	No	Yes	No		1"	1-1/4"	
	RHW	LHW	PR				Yes	No	Yes	No		1"	1-1/4"	

EXTENSION SPRINGS

QTY	WIRE	DIAMETER		LENGTH	LOOPS/CLIPS			DOOR TYPE		PO#/JOB NAME
		Circle One			Circle One	Circle One	Circle One	Circle One		
		ID	OD		Double	Single	Clips	Sectional	One-Piece	
		ID	OD		Double	Single	Clips	Sectional	One-Piece	
		ID	OD		Double	Single	Clips	Sectional	One-Piece	

ORDER BY PART

QTY	PART#	DESCRIPTION

QTY	PART#	DESCRIPTION



JAMB BRACKET CHART

BRKT #	DIM 'A'	DIM 'B'	PART NUMBER
1	2.39	1.875	1001
3	2.77	2.25	1003
4	3.02	2.5	1004
5	3.27	2.75	1005
6	3.52	3	1006
7	3.77	3.25	1007
8	4.02	3.5	1008
9	4.27	3.75	1009
10	4.52	4	1010
11	4.77	4.25	1011
12	5.02	4.5	1012
13	5.27	4.75	1013
14	5.52	5	1014

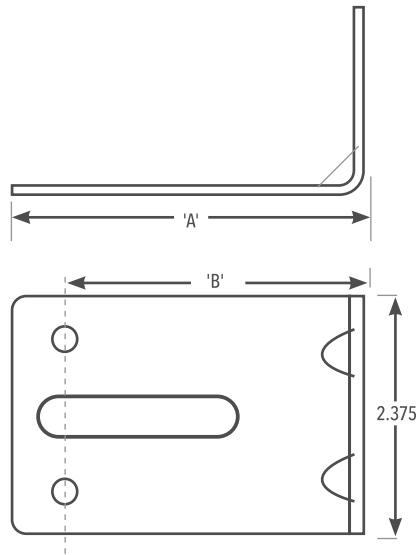

LIFTMASTER CIRCUIT BOARD CONVERSION CHART

1993-1997	Discontinued Boards	41A4252-6G	41A4252-7G	41D4674-1G					
		41A4252	41A4252-1	41D4674-1C					
		41A4252-4	41A4252-5	41D4674-1C					
		41A4252-6G	41A4252-7	41D4674-1E					
		41A4252-6A	41A4252-7A	41D4674-1F					
		41A4252-6B	41A4252-7B						
		41A4252-6C	41A4252-7C						
		41A4252-6D	41A4252-7D						
		41A4252-6E	41A4252-7E						
		41A4252-6F	41A4252-7F						
		1997-2005	Current Board	41A5021-I	41A5021-II	41A5021-5I	41D4674-14H	41D4674-10H	41A5389-1E
				Previous Versions	41A5021	41A5021	41A5021-D	41D4674-14D	41D4674-10
41A5021-B	41A5021-B				41A5021-5E	41D4674-14E	41D4674-10C	41A5389-1C	
41A5021-C	41A5021-C				41A5021-5F	41D4674-14F	41D4674-10D	41A5389-1D	
41A5021-D	41A5021-D				41A5021-5G	41D4674-14G	41D4674-10E	41A5389-1E	
41A5021-E	41A5021-E				41A5021-5H		41D4674-10F		
41A5021-F	41A5021-F						41D4674-10G		
41A5021-G	41A5021-G								
41A5021-H	41A5021-H								
41A5021-I	41A5021-I								
2001-2005	Current Board	41A5483C	41A5483-1C	41A5483-4C	41A5507B				
		Previous Versions	41A5483	41A5483-1	41A5483-4	41A5507			
			41A5483B	41A5483-1C	41A5483-4B				
2005-Current	Current Board		41AC050-1M	41AB050-2M					
		Previous Versions		41AC050-1	41AB050-2				



JAMB BRACKET



CONVERSION CHART

**REFERENCE
CHARTS**

A	
ADJUSTABLE SPREADER ARM.....	43
ALUMINUM RETAINER.....	123
B	
BEARINGS & PLATES.....	30–31
Center Bearing.....	30
End Bearing.....	30
Flange Bearing.....	31
Spring Failure Device.....	30
Steel Bearings & Bushing.....	31
BOTTOM BRACKETS.....	28
Res. & Comm. Bottom Bracket.....	28
Sure Stop Bottom Bracket.....	29
BRUSH SEAL.....	124–125
EZ Flex.....	125
Heavy Duty Nylon with Holder.....	125
Proseal Polypropylene with Holder.....	125
Sealeze Brush Seal & Entry Door Kits.....	124
Standard Duty Nylon with Holder.....	124
C	
CABLE.....	24
Cable Assemblies.....	24
Left Lay Reel of Cable.....	24
Premium Cable.....	24
Reel of Cable.....	24
Stainless Steel Cable.....	24
CABLE DRUMS.....	22
Hi - Lift.....	22
Standard Lift.....	22
Vertical Lift.....	22
CABLE FITTINGS.....	25–29
Clamp.....	25
Outside Hookup.....	29
Sleeve.....	25
Stop.....	25
Thimble.....	25
CABLE KEEPER.....	28
CARRIAGE DOOR.....	34–36
Cast Iron Handle.....	34
Cast Iron Hinge.....	35
Cast Iron Pull.....	35
Door Knock.....	34
Magnetic Door Hardware.....	36
Stamped Hinge.....	35
Stamped Pull Handle.....	35
Stud.....	35
CAST IRON LIFT HANDLE.....	35
CHAIN HOISTS & ACCESSORIES.....	32
Chain Hoist.....	32
Chain Hoist Rolling Steel Doors.....	32
Chain Tensioner.....	32
CHAIN PARTS & TOOLS.....	33
Chain Parts.....	33
Chain Tools.....	33
Master.....	33
Offset.....	33
Roller Chain.....	33
CHASE VINYL STRIP DOORS.....	140
COMMERCIAL EDGE SYSTEMS.....	92
Light Curtain.....	92
Optical Edge System.....	92
Photo Eye.....	92
Safety Edge.....	92

COMMERCIAL LIFTMASTER.....	78–87
Accessory Kit.....	85
Brake Solenoid.....	84
Cogged Belt.....	84
Commercial Accessories.....	81
Commercial Logic Board.....	85
Commercial Receiver.....	82
Commercial Relay.....	85
Dual Trolley Modification.....	81
Mounting Bracket.....	81
Operators.....	78–80
GH501L5.....	79
Gt501L5.....	80
H501L5R.....	78
H751L5R.....	79
J501L5.....	78
LJ8900W.....	80
LJ8950W.....	80
MH5011UL.....	78
MH5011UR.....	78
MJ5011U.....	78
MT5011U.....	79
T501L5.....	79
T751L5.....	80
Photo Cell.....	87
Photo Cell Kit.....	84
Replacement Chain.....	81
Replacement Parts.....	84
Transformer.....	84
COMMERCIAL MOTION DETECTOR.....	98
COMMERCIAL PHOTO CELLS.....	83
Antenna.....	83
Door & Gate Photo Cell.....	83
Keypads.....	83
COMMERCIAL WALL STATION.....	99
Bell Wire.....	100
Ceiling Pull Switch.....	100
Control Station.....	99–100
Interlocking Switch.....	100
Keyed Outside Disconnect.....	100
Key Switch.....	100
Metal Key Switch.....	100
Push Button.....	100
D	
DOCK EQUIPMENT.....	142–144
4.5" Laminated Dock Bumper.....	142
6" Laminated Dock Bumper.....	142
9" Laminated Dock Bumper.....	143
Bumper Installation Hardware.....	144
Dock Leveler.....	144
Loading Light.....	144
Overhead Door Track Protector.....	144
Specialty Molded Bumper.....	143
Wheel Chock.....	144
DOOR BUMPERS.....	39
E	
ENTRY DOOR CLOSER.....	113
Entry door closer.....	113
EXHAUST PORTS.....	38
EXTENSION HARDWARE.....	34
One Piece.....	34
Spring Clip.....	34
EXTENSION HARDWARE BOXES.....	42
EXTENSION SPRING.....	18–19
7' High Clipped Ends.....	19
7' High Double Loops.....	19
7' High Open Loops.....	19
8' High (27-48) Double Loops.....	19
H-Style.....	18

F	
FASTENERS.....	40–41
Clevis Pin.....	40
Cotter Pin.....	40
Flange Nut.....	41
Flat.....	41
Flat Washer.....	40
Hex Head Bolt.....	40
Hex Nut.....	41
Keps Nut.....	41
Lag Screw.....	40
Round.....	41
Self Drill & Tap Tek.....	40
Set Screw.....	41
Sleeve Anchor.....	41
Tapcon Screw.....	41
Track Bolt.....	41
Type AB.....	40
FOLDING GATE.....	145
Double Folding Gate.....	145
Single Folding Gate.....	145
FORMS.....	162–164
Account Application.....	163
ACH Electronic Payment Authorization Form.....	162
Fax Order Form.....	164
FORMS FOR QUOTES.....	151–161
Chase Vinyl Strip Door.....	159
Commercial Operator.....	156
LiftMaster Gate.....	155
Miller Edge for Door.....	160
Miller Edge for Gate.....	161
Multi-Purpose Lube Private Label.....	152
Mystic Classic Screen.....	158
Trailer Ramp Door.....	157
T & W Style Door.....	151
Ultra Gel Private Label.....	153
Z-45 Penetrating Lube Private Label.....	154
G	
GATE ACCESSORIES LIFTMASTER.....	105
Access Control.....	105
Pad Mount Pedestal.....	105
GATE HARDWARE.....	112–113
Cantilever Roller.....	112
Gate Latch.....	112
Gate Lock.....	113
Gate Receiver.....	112
Mounting Bracket.....	113
Power Wheel.....	112
Roller Bracket.....	113
V-Track.....	112
Wheel Cover.....	112
GATE HINGE HARDWARE.....	108–110
Adjustable.....	110
Heavy Duty Gate Hinges.....	109
Specialty.....	110
Standard Duty Gate Hinges.....	108
Tamperproof.....	110
GATE LINEAR.....	107
Accessories.....	107
SW3000XLS.....	107
SW3200XLS.....	107
SW4000XLS.....	107
SW4200XLS.....	107
GATE OPERATORS LIFTMASTER.....	104
Barrier Gate.....	104
Barrier Gate Arm.....	104
GUIDE ROLLER HARDWARE.....	111
Guide Roller.....	111
Single Guide Roller.....	111

H

HINGES	25-26
11 Gauge.....	26
11 Gauge Quiet hinge.....	26
14 Gauge.....	26
14 Gauge Narrow Rail.....	26
16 Gauge.....	26
18 Gauge.....	26
Quiet Hinge.....	25
Quiet Hinge Kit.....	25

L

LIFE OF A SPRING	6-7
LIFESTYLE SCREENS	139
Accessories.....	139
LOCKS	37
Dead Bolt Lock & Parts.....	37
Keyed Outside.....	37
Latch Set & Parts.....	37
Lock.....	37
Slide Lock.....	37
LOOP	89-91
BD Loop Tools.....	91
Direct Burial Loop.....	90
Loop Detector.....	89
Loop Tools & Accessories.....	89
Saw-Cut Loop.....	91
Sealant.....	91
Wedge Tool.....	89

LOW HEADROOM

EZ Kit.....	39
O&E LH Bracket.....	39
Quick Close Fixture.....	39
Super Sneaky Low Headroom.....	39

LUBRICANTS..... 126-127

Chain & Cable.....	127
Foamy.....	127
Getsome.....	127
Lubriplate.....	127
Multi-Purpose.....	126
Pro 21.....	127
Pro SL.....	127
Silicone.....	126
Slip It.....	127
SSCAYD.....	126
SSC123.....	126
Ultra Gel.....	126
Z-45.....	126

M

MILLER EDGE	94-95
Accessories.....	96
Light Curtain.....	96
Rolling Door / Gate.....	94-95
MC22.....	94
ME110.....	95
ME111.....	95
ME120.....	95
MGR20.....	95
MGS20.....	95
MT21.....	95
MT22.....	95
Sectional.....	94
ME112.....	94
ME113.....	94
ME116.....	94
ME117.....	94
ME123.....	94
MGO20.....	94
MU21.....	94
MU22.....	94
Sensing edge.....	96

MINI WAREHOUSE	136
Latch Accessories.....	137
Lift Handle.....	137
Slide Bolt Latch.....	136
Springs.....	137
"T" Bottom Seal.....	136

MISCELLANEOUS HARDWARE	42-43
Adjustable Spreader Arm.....	43
Extension Hardware Boxes.....	42
Fire Door Accessories.....	42
Flag Bracket.....	42
Jamb Bracket.....	43
Junction Plate.....	42
Lift Handle.....	43
Pull Rope.....	42
Section Saver.....	43
Splice Plate.....	42
Step Plate.....	42
Strut Clip.....	42
Torsion Hardware Boxes.....	42
Vertical Angle.....	43

MYSTIC MOTORIZED SCREENS	138
Classic.....	138
Electronics.....	138

O

OPERATOR BRACKETS	38
ARB Adjustable.....	38
Lock Parts.....	38
ORB.....	38
ORB Narrow.....	38
T-Rail Mounting Bracket.....	38

ORDERING INFORMATION	4-5
Duplex & Triplex.....	4
Extension Springs.....	5
Formulas & Rules.....	9
Galvanized.....	5
Mini Warehouse.....	5
Powder Coated.....	5
Square Wire.....	5
Torsion Spring Ends.....	8

P

PERFORATED ANGLE	44
1 1/2" x 1 1/2" Galvanized.....	44
1 1/4" x 1 1/4" Galvanized.....	44
1 1/4" x 1 1/4" Powder Coated.....	44
1 5/8" x 23/8" Galvanized.....	44
2" x 2" Galvanized.....	44

PNEUMATIC	97
Coil Cord.....	97
Cord Reel.....	97
Entry Access.....	97
Pneumatic Parts.....	97

POWDER COATING	12
2" ID Standard Powder Coating.....	12

PULLEYS & FORKS	23
Fork.....	23
Hardware.....	23
Pulley.....	23

R

REFERENCE CHARTS	165
Jamb Bracket Chart.....	165
LiftMaster Circuit Board Conversion Chart.....	165

RESIDENTIAL ALLSTAR	75
----------------------------------	----

RESIDENTIAL DIGI-CODE	73
Keyless Entry.....	73
Photo Cell.....	73
Radio Set.....	73
Receiver & Remote.....	73

RESIDENTIAL GENIE	70-72
Carriages.....	71
Control Boards and Receivers.....	71
Dual Frequency Remote.....	70
Genie Capacitors.....	71
Operator.....	70
6070H.....	70
6170HB.....	70
Remote.....	70
Replacement Parts.....	72
Universal Keypad.....	70
Wall Console.....	70

RESIDENTIAL GUARDIAN	66-67
Keypad.....	67
Operator.....	66
415CC.....	66
615CC.....	66
628CC.....	66
715BBU.....	66
928DC.....	66
Remotes.....	67

RESIDENTIAL HEDDOLF	76
Remote.....	76

RESIDENTIAL LIFTMASTER	48-62
390 MHz.....	55
Camera.....	49
Deadbolt.....	49
Gate Logic Board.....	59
Gears & Sprockets.....	61
Installation Accessories.....	57
Keypad.....	56
Lever Lock.....	49
Max Remote Control.....	54
Miscellaneous Parts.....	62
MyQ Enabled Accessories.....	57
Operator.....	48-53
8160W.....	51
8500.....	52
8500W.....	52
81550.....	51
81640.....	50
81650.....	50
83650-267.....	50
84504R.....	48
84602.....	48
85870.....	50
87504-267.....	48
87802.....	48
ATSW.....	51
DDO8900W.....	53
Operator Accessories.....	56
Power Door Lock.....	62
Purple Smart Button.....	58
Receiver.....	54
Red Smart Button.....	58
Remote Universal.....	54
Replacement Belt.....	62
RPM Sensor.....	60
Safety Sensor Kit.....	60
Security+2.0.....	55
Security+315 MHz.....	55
Trolley Assembly.....	60
Wall Console.....	54
Wire-Hide Wall Plate Kit.....	57
Yellow Smart Button.....	59

RESIDENTIAL LINEAR	63-64
Battery Backup.....	63
Delta 3.....	64
Keyless Entry.....	64
Linear Parts.....	64
Linear Remote.....	63
Mega Code 1 & 3 Button Remote.....	64
Operators.....	63
LDCO801.....	63
LDCO841.....	63

Residential Linear Operators	63
LDC0863B.....	63
LDO50	63
Visor Remote	64
RESIDENTIAL MARANTEC	69
Keypad	69
LED Lighting Kit	69
Operator	69
270.....	69
280.....	69
370.....	69
380.....	69
Operator Accessories	69
Remotes.....	69
Wall Console.....	69
RESIDENTIAL MULTI-CODE.....	74
300 MHz Receiver	74
Control Board	75
Keyless Entry	74
Keyless Entry 318 MHz	75
Radio Set 300 MHZ.....	74
Receivers 318 MHz.....	75
Remote	74
Remote 318 MHz.....	75
RESIDENTIAL UNIVERSAL	76
Remote	76
Wired Keypad	76
ROLLERS	27
2" Car Wash	27
2" Nylon Capped Roller	27
2" Nylon Roller.....	27
2" Nylon Roller Precision Bearing.....	27
2" Steel Roller.....	27
3" Car Wash	27
3" Steel Roller.....	27
S	
SHAFT COLLAR	45
SHAFT COUPLER	45
SHAFT KEYS.....	45
SHAFTS.....	46
1 1/4" Solid Shaft	46
1" Solid Shaft.....	46
1" Tube Shaft.....	46
SHIPPING ZONES	2-3
SPRING FILLER.....	21
SPRING WEIGHT CHART PER INCH.....	11
STAMPED LIFT HANDLE.....	35
STATIONARY & WINDING CONES	20-21
STRUTS.....	46
2 1/4" Strut	46
3" Strut.....	46
SURE STOP BRACKETS.....	29
SWING GATE LIFTMASTER	102
Operators.....	102
LA400UL	102
LA412UL	102
LA500UL	102
SWING & SLIDE GATE LIFTMASTER.....	103
Operators.....	103
CSL24UI.....	103
CSW24UI	103
CSW200UL	103
RSL12UI.....	103
RSW12UL	103
SL3000UI	103

T

TOOLS.....	128-135
Angle Cutter.....	134
Batteries	130
Bearing Blaster	131
Cable Cutter.....	132
Cable Hoist	133
Cable Puller	133
Cable Swager	133
Cobalt Drill Bit.....	135
Concrete Screw	135
Counter Balance Lever Arm	132
Cutoff Wheel	135
Donkey Cone	132
Door Stacker	132
High Speed Steel Drill Bit.....	135
Impact Tool	134
Irwin Vise-Grip Tool.....	134
Measuring Tool	132
Milwaukee Tools	128-130
Batteries & Chargers	128
Drill, Impact & Driver tools	128
Grinder	128
Jobsite Tools	128
Miscellaneous Tools	129
Power Saws & Kits.....	128
Tool Organizers	130
Multi-Cut Tool.....	134
Pocket Wire Gauge	131
Rack Strap	135
Reciprocating Saw Blade.....	135
Roller Chain	133
SDS Carbide.....	135
Spring Repair Block	131
Spring Spreader Tool	132
Spring Wire Gauge.....	131
Straight Shank	135
Swager Kit	133
Towels.....	131
Winding Bar	132

TOP FIXTURES..... 28

ADJUSTABLE TOP FIXTURE.....	28
Low Headroom	28
Torsion Springs	14-15
1 3/4" ID Standard Torsion Springs.....	14
2" ID Standard Torsion Springs	15
2" Long Length Coated - 120".....	16
1 3/4" Long Length Coated - 120"	16

TRACK.....	45
2" Horizontal Punched Track	45
2" Low Headroom Horizontal Track.....	45
2" Vertical & Raw Track.....	45

TRUCK TRAILER DOORS..... 146-150

3/4" T-Style Door Parts Index	146-150
Bottom Seal.....	147
Bracket & Fixture.....	147
Cable.....	147
Hinge.....	147
Lock.....	147
Nut	147
Pin	147
Roller & Drum	147
Section	147
3/4" W-Style Door Parts Index	148-149
Bracket & Fixture	149
Cable.....	149
Hinge.....	149
Lock.....	149
PVC Spring Filler	149
Roller & Drum	149
Section	149

V

V BELTS.....	86
1/2" V Belt	86
3/8" V Belt.....	86
5/8" V Belt	86

W

WALL CONSOLE..... 67

WEATHER SEAL..... 115-123

1 1/2" CP-150	120
1 3/4" AR-175.....	121
1 3/4" CP-06	120
1 3/4" CP-134OFB	121
1 3/4" Door Stop DS-134	117
1 3/4" TC-175	122
1 3/8" AR-138.....	121
1 3/8" ARL-138.....	121
1 3/8" CP-05.....	120
1 3/8" CP-138OFB	121
1 3/8" TC-138.....	122
1 5/8" CP-158.....	120
1 5/8" TC-158.....	122
2 5/8" Door Stop DS-258	117
2 5/8" Rolled Door Stop	118
2" AR-02	121
2" ARL-200	121
2" CP-07.....	120
2" CP-07OFB.....	121
2" CP-10	120
2" Door Stop DS-200	117
2" Rolled Door Stop	118
2" SL-08.....	122
2" TC-200	122
2" TG-200	122
3 1/4" Residential	119
4" Bottom Seal.....	119
Adapter Rail	122
Adhesive	118
Astragal Retainer	119
Baffle	123
Bottom Bead Seal	119
Clip On Jamb Seal.....	118
Garage Door Threshold	119
GS-20.....	122
GS-38.....	122
Header Seal	123
HS-22S	123
Nail Astragal	118
RB-21F.....	122
Reverse Seal.....	118
Ring Shank.....	118
Single T Bottom Seal.....	119
Smooth Shank.....	118
SNP001	123
TS-14	122
TS-15	122
TS-200	122
TS-300	122
UNI-100.....	120
UNI-300.....	120
Uniflex.....	115
Universal Retainer	119
Wood Door Bottom Seal	118

SOMETHING NEW IS ON THE HORIZON

SSC takes pride in being one of the overhead door industry's leading suppliers. As we move forward, we continue to develop new products and strive to be your one-stop shop. Stay tuned to our social media channels for some exciting new product developments in 2023!

Copyright ©2023 Service Spring Corporation (SSC). All rights reserved. All catalog materials are the property of SSC and may not be copied, reproduced, sold, or distributed without the expressed written permission of the copyright holder.

CORPORATE OFFICE:

1703 Tollgate Drive
Maumee, OH 43537

CUSTOMER SERVICE HOURS:

Monday - Friday
7:30 AM - 6:00 PM (Eastern)
4:30 AM - 3:00 PM (Pacific)



Follow us on:   

Current Pricing can be viewed at servicespring.com or call
833.772.3667 | Monday – Friday 7:30am–6:00pm (EST)